



Logistics in CDEM

Director's Guideline for Civil Defence
Emergency Management Groups [DGL 17/15]



Resilient New Zealand
Aotearoa Manahau

[New Zealand Government](https://www.nz.govt.nz)

Logistics in CDEM

Director's Guideline for Civil Defence Emergency Management Groups [DGL 17/15]

June 2015

ISBN 978-0-478-43505-4

Published by the Ministry of Civil Defence & Emergency Management

Authority

This guideline has been issued by the Director of the Ministry of Civil Defence & Emergency Management pursuant to s9(3) of the Civil Defence Emergency Management (CDEM) Act 2002. It provides assistance to CDEM Groups in the preparation for, and carrying out, of logistics activities during emergency response and recovery.

This document is not copyright and may be reproduced with acknowledgement. It is available, along with further information about the Ministry, on the MCDEM website www.civildefence.govt.nz.

Cover images

Clockwise from bottom left: Auckland Ambury Farm Day, image courtesy Steven Matthews Photo Fever Ltd; Helicopter taking off, image courtesy Waikato CDEM Group; Donated goods at the Red Cross warehouse, Palmerston North, image courtesy of Manawatu-Wanganui CDEM Group.



Ministry of Civil Defence & Emergency Management
PO Box 5010
Wellington 6145
New Zealand
Tel: +64 4 817 8555
Fax: +64 4 817 8554

Email: emergency.management@dpmc.govt.nz

Website: www.civildefence.govt.nz

Foreword



Logistics is a key part of a successful response. It involves the provision of the right resources at the right time, in the right place, in the right quantities, and in the right condition. This is no easy task during an emergency, when resources run short and normal resupply arrangements are often disrupted. Without the correct resources, responders may not be able to operate effectively, possibly endangering lives and property. Logistics is therefore a key enabler, helping to lay the foundation for other response functions to meet the needs of the community.

This guideline aims to provide a consistent approach to carrying out logistics across all agencies involved in response or recovery. It gives a thorough overview of the Logistics function, how it is applied in a CDEM context, and includes a number of templates and suggested processes to make this information more accessible.

The audience for this document includes Logistics function staff, Controllers, and other functions who work closely with Logistics. In particular it will serve as a key reference for training and professional development for Logistics function staff.

By detailing the Logistics function and its outputs, requirements, and internal processes, this guideline will help lay the foundation for logistics to be carried out more efficiently and effectively during future emergencies.

Sarah Stuart-Black

Director of Civil Defence Emergency Management

Acknowledgements

This document is the product of a collaborative effort between the Ministry of Civil Defence & Emergency Management, and regional and local civil defence emergency management personnel.

Contents

Section 1 Introduction	1
1.1 About this guideline	1
1.2 About CDEM.....	5
Section 2 CDEM Logistics	9
2.1 CDEM Logistics principles	9
2.2 Logistics and CDEM	9
2.3 Logistics and CIMS.....	13
2.3.2 The CDEM Emergency Management Information System (EMIS)	18
Section 3 The Logistics sub-functions	19
3.1 Summary	19
3.2 Logistics Management.....	20
3.3 Finance.....	20
3.4 Supply	21
3.5 Information Communication Technology (ICT).....	23
3.6 Administration.....	25
3.7 Transport	25
3.8 Catering.....	29
3.9 Facilities	31
3.10 Personnel.....	32
Section 4 Resource processes.....	33
4.1 Resource assessment	33
4.2 Procuring resources.....	35
4.2.1 Procurement sources.....	35
4.2.2 Resource requests.....	37
4.2.3 Procurement considerations	39
4.2.4 Purchasing.....	40
4.2.5 Requisitioning	42
4.3 Resource management.....	44
4.3.1 Receiving resources	45
4.3.2 Storing resources.....	45
4.3.3 Issuing resources.....	46
4.3.4 Return or disposal of resources	47
4.3.5 Tracking resources	47
Section 5 Readiness	48
5.1 Gathering information	49
5.2 Planning and setting up	50
5.2.1 Output assessment.....	50
5.2.2 Risk assessment.....	50
5.2.3 The Logistics team.....	51
5.2.4 Logistics workspaces	54
5.2.5 Other Logistics resources	55

5.3 Developing processes and supporting documentation.....	56
5.3.1 Planning	57
5.3.2 Role descriptions.....	58
5.3.3 Assessing likely resource needs.....	58
5.3.4 Assessing critical resources	58
5.3.5 Setting up contracts or MOUs.....	59
5.3.6 Purchasing and payments	59
5.3.7 Review operational plans	60
5.3.8 Archiving	60
5.4 Training and development.....	61
Section 6 Response and recovery.....	63
6.1 Starting up.....	63
6.2 Response actions.....	64
6.2.1 Logistics contribution to the Action Plan	64
6.2.2 Transportation priority list	66
6.3 Ongoing tasks	67
6.3.1 Identifying critical resources	67
6.3.2 Purchasing and payments	67
6.3.3 Requisition	68
6.3.4 Receiving goods.....	68
6.3.5 Transport.....	68
6.3.6 Monitoring and evaluation.....	69
6.4 Winding down.....	70
6.4.1 Managing resources.....	70
6.4.2 Applying for Government assistance	71
6.4.3 Debriefing the Logistics team	71
6.4.4 Reviewing procedures and documentation	71
Section 7 Appendices.....	72
APPENDIX A Centre and Field Logistics	73
APPENDIX B Assembly Areas and Staging Areas.....	74
APPENDIX C Developing a Logistics CDEM Plan	79
APPENDIX D Government financial assistance	82
APPENDIX E Content for forms.....	87
APPENDIX F Logistics readiness checklist.....	92
APPENDIX G Logistics response procedure.....	94
APPENDIX H Logistics response checklist	97
APPENDIX I Logistics Appendix for the Action Plan-template.....	100
APPENDIX J Logistics Appendix for the Action Plan-example	102
APPENDIX K Resource Request procedures	105
APPENDIX L Task log	108
APPENDIX M Task sheet	110
APPENDIX N Procurement phases during an emergency	111
APPENDIX O Transport background information.....	114
APPENDIX P Glossary	116

SECTION 1 INTRODUCTION

This section provides an introduction to this guideline and includes a list of the key terms used.

1.1 About this guideline

The **purpose** of this guideline is to describe the Logistics function in the context of Civil Defence Emergency Management (CDEM).

The **objectives** of this guideline are to:

- create a common understanding of logistics across all CDEM stakeholders
- streamline logistics actions between agencies, and
- provide a basis for logistics training and professional development.

This guideline is subordinate to the *National CDEM Plan* and the *Coordinated Incident Management System (CIMS) Manual, 2nd edition*. It is intended to expand on the information contained in the logistics sections of those documents.

The **intended audience** of this guideline is:

- Controllers
- CDEM Logistics Managers
- members of CDEM Logistics teams, and
- staff developing or delivering logistics training and development.

Structure

This guideline has the following main sections:

- Section 1 [Introduction](#) – an introduction to this guideline, including a clarification of the key terms
- Section 2 [CDEM Logistics](#) – background information, including logistics within CDEM and CIMS
- Section 3 [The Logistics sub-functions](#) – descriptions of each of the Logistics sub-functions
- Section 4 [Resource processes](#) – the processes required for managing resources
- Section 5 [Readiness](#) – logistics tasks before an emergency
- Section 6 [Response and recovery](#) – logistics tasks during and following an emergency
- Section 7 [Appendices](#) – information, templates, and forms that support logistics.

Use of icons

The following icons are used in this guideline:



Indicates a template is provided in the appendices.



Indicates more information is available in another document or website.

Key terms

CDEM

In this document, **Civil Defence Emergency Management (CDEM)** has the same meaning as in the *CDEM Act 2002*:

4 Interpretation...

civil defence emergency management—

- (a) means the application of knowledge, measures, and practices that—
 - (i) are necessary or desirable for the safety of the public or property; and
 - (ii) are designed to guard against, prevent, reduce, or overcome any hazard or harm or loss that may be associated with any emergency; and
 - (iii) includes, without limitation, the planning, organisation, co-ordination, and implementation of those measures, knowledge, and practices.



A full description of CDEM (including a full glossary of terms and abbreviations) is provided in the *Guide to the National CDEM Plan*, available at www.civildefence.govt.nz by searching the document name.

Emergency

In this document, **emergency** has the same meaning as in the *CDEM Act 2002*:

4 Interpretation...

emergency means a situation that—

- (a) is the result of any happening, whether natural or otherwise, including, without limitation, any explosion, earthquake, eruption, tsunami, land movement, flood, storm, tornado, cyclone, serious fire, leakage or spillage of any dangerous gas or substance, technological failure, infestation, plague, epidemic, failure of or disruption to an emergency service or a lifeline utility, or actual or imminent attack or warlike act; and
- (b) causes or may cause loss of life or injury or illness or distress or in any way endangers the safety of the public or property in New Zealand or any part of New Zealand; and
- (c) cannot be dealt with by emergency services, or otherwise requires a significant and co-ordinated response under this Act.

Note that this definition of an emergency is different from the one used in the Coordinated Incident Management System (CIMS). CIMS is not based on the *CDEM Act 2002*, and a modified definition is required for other agencies using CIMS, particularly emergency services.

CIMS



The **Coordinated Incident Management System (CIMS)** is the primary reference for incident management in New Zealand. The purpose of CIMS is to achieve effective coordinated incident management across responding agencies for all incidents regardless of hazard, size and complexity.

Logistics is one of the functions of CIMS. CIMS is described in detail in the *CIMS Manual*, 2nd Edition, available at www.civildefence.govt.nz by searching for the document name.

Logistics and the 4Rs

The *National CDEM Plan* describes the 4Rs of emergency management as being reduction, readiness, response, and recovery. Their definitions are given in Appendix P [Glossary](#) on page 116.

The Logistics function does not have any direct responsibilities relating to **reduction**, although all readiness and response activities reduce risk.

Preparation to ensure effective and sustainable logistics during response occurs during **readiness**.

The Logistics function is activated and delivered during **response** and **recovery**. Response and recovery are combined in this guideline, as there is significant overlap between them.

Logistics Manager

During readiness, the **Logistics Manager** prepares information on and arrangements for logistics resources and processes, for use in response and recovery. In smaller CDEM Groups that do not have a full time Logistics Manager, this role may be performed by a member of the emergency management team.

The Logistics Manager during response and recovery is the person responsible for managing the Logistics function at the coordination centre.

The position of Logistics Manager is non-statutory.

Logistics team

The **Logistics team** includes any personnel who are assigned to the Logistics Manager before, during, or after an emergency.

Business as usual CDEM facilities

GEMO

GEMO (Group Emergency Management Office) is the regional office where CDEM functions are carried out on behalf of the CDEM Group before an emergency occurs. It is managed by the GEMO Manager.

EMO

EMO (Emergency Management Office) is the office(s) where CDEM functions are carried out at a local level before an emergency occurs. The person who carries out the CDEM functions is the EM Officer.

CDEM response facilities

Coordination centre A **coordination centre** is the location from which a Controller and Incident Management Team (IMT) manages a response. There are four types of coordination centre:

- Incident Control Points (ICPs) operate at an incident level
- Emergency Operations Centres (EOCs) operate at a local level
- Emergency Coordination Centres (ECCs) operate at a CDEM Group level, and
- National Coordination Centres (NCCs) operate at the national level.

NCMC The **NCMC (National Crisis Management Centre)** is a secure, all-of-government coordination centre used by agencies to monitor, support, or manage a response at the national level.

It is an example of a National Coordination Centre (NCC).

MCDEM is responsible for maintaining the NCMC in a state of readiness, and will act as the lead agency for CDEM-led responses.

ECC An **ECC (Emergency Coordination Centre)** is a coordination centre that operates at the CDEM Group level to coordinate and support one or more activated EOCs.

EOC An **EOC (Emergency Operations Centre)** is a coordination centre that operates at a local level to manage a response.

ICP An **ICP (Incident Control Point)** is a coordination centre that operates at the incident level to manage a response.

CDC A **Civil Defence Centre (CDC)** is a facility that is established and managed by CDEM during an emergency to support individuals, families/whānau, and the community. CDCs are open to members of the public, and may be used for any purpose including public information, evacuation, welfare, or recovery, depending on the needs of the community.

CDCs are operated by CDEM-led teams (including CDEM-trained volunteers), or by other agencies as defined in CDEM Group Plans or local level arrangements.

Community-led centres Community members and/or community-based organisations may establish and operate other centres that offer support to the community.

These centres do not fall under the direction of CDEM, although they may coordinate with and operate alongside CDEM-led facilities.

1.2 About CDEM



This is a brief overview, intended for people who have not been involved in CDEM before. More information is available in the *Guide to the National CDEM Plan*, available at www.civildefence.govt.nz by searching for the document name.

MCDEM

Ministry of Civil Defence & Emergency Management (MCDEM) is the central government agency responsible for providing leadership, strategic guidance, national coordination, and the facilitation and promotion of various key activities across the 4Rs (reduction, readiness, response, recovery). It is the lead agency at a national level responsible for coordinating the management of the emergencies listed in the *National CDEM Plan*.

MCDEM may act as a support agency by coordinating the CDEM response to any given emergency managed by another lead agency. MCDEM is responsible for maintaining the National Crisis Management Centre (NCMC), and the National Warning System.

CDEM Group

In this guideline, **CDEM Group** refers to the collective of local authorities, emergency services, and other agencies that work together to implement CDEM in their area. **CDEM Group** may also refer to the committee of elected officials that are accountable for CDEM in their area.

CDEM Groups are required under the *CDEM Act 2002*; every local authority is required to be a member of a CDEM Group.

There are 16 CDEM Groups in New Zealand. Each is responsible for CDEM in its area, including:

- identifying and managing hazards and risks
- providing the organisational structure and resources necessary (including suitably trained personnel) for the effective delivery of CDEM
- undertaking CDEM readiness activities, including raising public awareness about CDEM and preparing a CDEM Group Plan
- coordinating or undertaking CDEM response and recovery activities, and
- providing support and assistance to other CDEM Groups, if required.

Business as usual CDEM structure

The general structure of a CDEM Group is shown in Figure 1 below. Variations to this structure are discussed below.

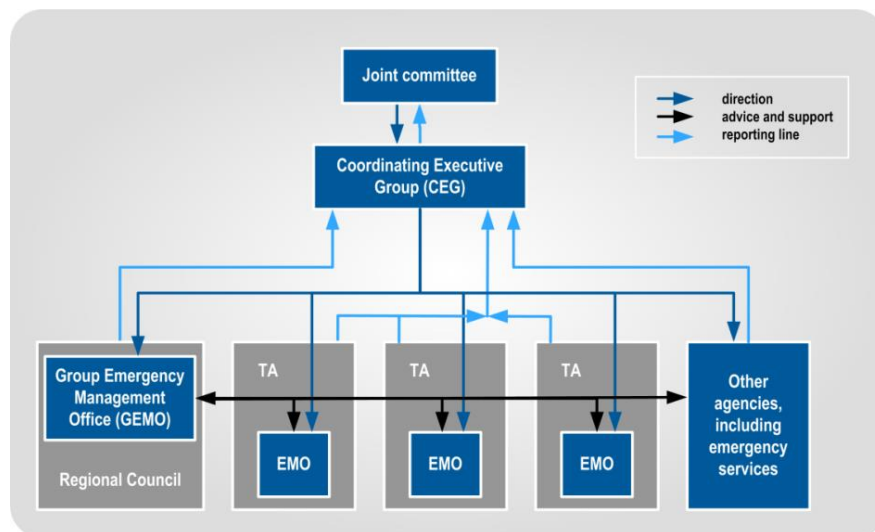

Figure 1 CDEM structure for business as usual

Joint committee

The **Joint Committee** is part of a CDEM Group's structure. It is made up of elected representatives of member authorities, such as mayors, chairpersons, or their delegates. In CDEM Groups with a unitary authority structure, the Joint Committee is a committee of council, or a council functioning as a CDEM Group.

CEG

The **Coordinating Executive Group (CEG)** is part of a CDEM Group's structure. It is made up of chief executives (or their delegates) of local authorities, representatives of emergency services, and others.

Variations in CDEM Group structure

CDEM structures vary significantly in different CDEM Groups. The CDEM Group Plan will show their particular structure. The main variations in structures are:

- GEMO with no local EMO(s) (includes unitary authorities)
- all or some of the EMOs reporting through the GEMO, rather than through the territorial authorities
- pooling territorial resources to jointly provide all CDEM functions in the CDEM Group's region
- grouping EMOs under area offices over several local councils, and
- the CDEM Group contracting out provision of CDEM to a third party, who reports directly to the CEG.

CDEM response structure

The structure of a national emergency response is shown Figure 2 below:

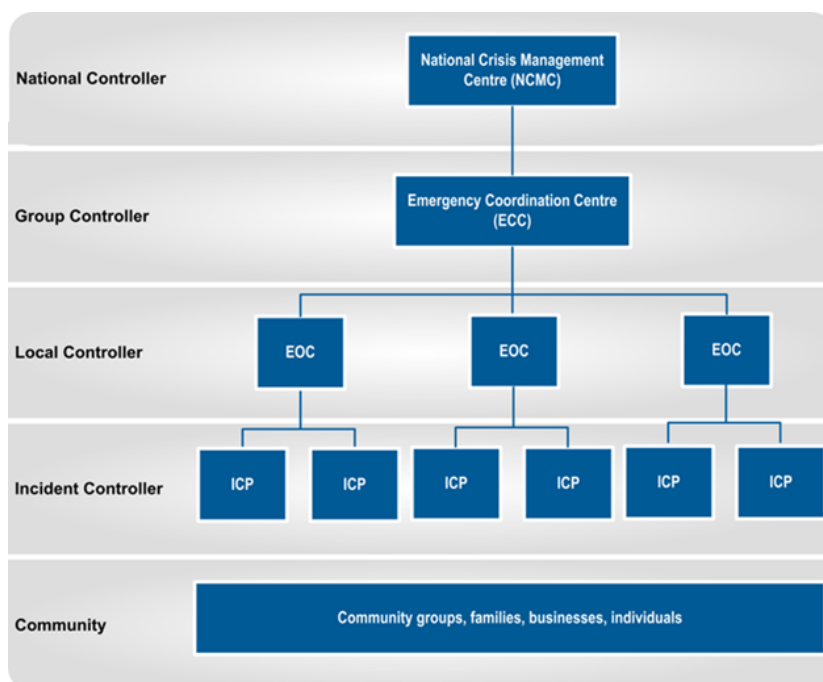

Figure 2 CDEM structure during response

A **Controller** is the person in charge of the response (or part of the response) at each coordination centre, and at each level of response coordination.

NCMC, Group ECCs, local EOCs and ICPs (at national, CDEM Group, local and incident level respectively) are structured according to the CIMS. See section 2.3 [Logistics and CIMS](#) on page 13 for more information.

Key CDEM documents

CDEM Act 2002

The **Civil Defence Emergency Management Act 2002 (CDEM Act 2002)** provides the legislative framework for CDEM in New Zealand across the 4Rs. It describes the functions and responsibilities of the Director of CDEM, as well as those of government departments, local authorities, emergency services, and lifeline utilities.

The *CDEM Act 2002* sets the requirement for CDEM Groups, and defines their statutory functions, duties, and responsibilities. It also provides for local authority delegated representatives, mayors, or the Minister of Civil Defence to declare a state of local emergency (the Minister may also declare a state of national emergency), and defines the powers that CDEM Groups and Controllers may exercise during a state of emergency.

The *CDEM Act 2002* requires there to be a *National CDEM Strategy* and a *National CDEM Plan*, and enables the Director of CDEM to issue Director's Guidelines.

The National CDEM Strategy

The **National CDEM Strategy** describes the intentions of the Crown regarding CDEM provisions. It outlines the vision, values, principles, and goals for CDEM, and is reviewed every ten years.

National CDEM Plan

The **National CDEM Plan** is a regulation that describes the actions required across the 4Rs, and who carries them out.

The Guide to the National CDEM Plan

The **Guide to the National CDEM Plan** explains the *National CDEM Plan* in detail.

CDEM Group Plan

Each CDEM Group is required under the *CDEM Act 2002* to have a **CDEM Group Plan**, which is regularly reviewed.

The CDEM Group Plan sets the strategic direction for the CDEM Group. It describes and prioritises the hazards and risks particular to the CDEM Group's area, and provides objectives and a framework for activities across the 4Rs.

Director's Guidelines

Director's Guidelines are documents developed by MCDEM, to provide guidance to CDEM Groups and other agencies regarding CDEM. They are issued by the Director of CDEM under the *CDEM Act 2002*.

CIMS Manual

The **Coordinated Incident Management System (CIMS) Manual 2nd Edition** describes the arrangements used to coordinate incident management responses between agencies, regardless of the hazard, size and complexity.

It is not a CDEM document, but contains important detail on how CDEM responses are structured and coordinated.

SECTION 2 CDEM LOGISTICS

The role of logistics in emergency management is to provide the resources required by response personnel and the affected population. Resources must be provided in good condition, at the right time, to the right place, and in the right quantities.

2.1 CDEM Logistics principles

The principles used in CDEM Logistics are as follows:

- **Business as usual (BAU) systems:** using BAU processes and systems wherever possible
- **Preparation:** preparing systems and processes (for resource identification, procurement, deployment, financial tracking, and accountability reporting) before responses is far superior to setting them up during a response
- **Collaboration:** using a collaborative approach to logistics planning (involving all stakeholders) before and during an emergency enables a coordinated response
- **Management by exception:** using normal procurement systems, unless agencies or Controllers identify resources as critical to a response. Logistics, with the Operations function, actively manages the procurement and assignment of critical resources with the agencies requiring or providing them
- **Responsibility:** understanding that agencies are responsible for the procurement of their own resources (but may request assistance from other agencies through their respective Controllers), and
- **Local sourcing:** using local resources, where practicable, before using those from other areas.

2.2 Logistics and CDEM

As shown in Figure 3 on the next page, CDEM Logistics teams in coordination centres:

- focus on logistics within their own area; CDEM Groups and territorial authorities provide direct support only within their boundaries
- provide support via Resource Requests from higher response levels to lower; NCMC to ECCs, ECCs to EOCs and EOCs to ICPs
- CDEM Groups and territorial authorities can provide support outside their boundaries where this is agreed and coordinated with higher and supported coordination centres, and
- procurement can happen outside boundaries, but this may be controlled and coordinated for critical resources.

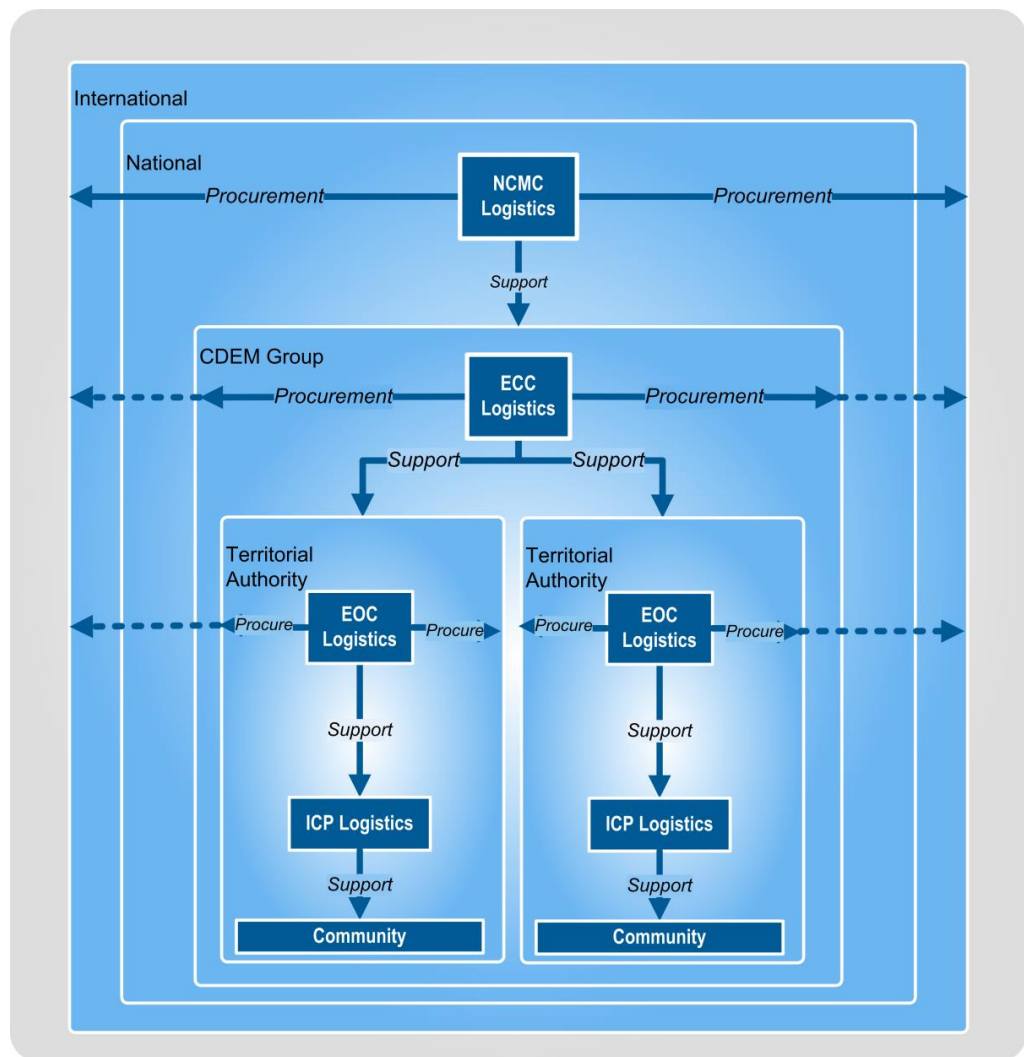

Figure 3 CDEM Logistics focus and support

National CDEM Logistics structure

There are four levels of CDEM Logistics:

- National (NCMC)
- Group (regional, ECC)
- Local (EOC), and
- Incident (ICP).

Each focuses on providing for its own level of response, and supporting the level below, as shown in Figure 3 above. During most emergency responses only incident and local level logistics are required.

CDEM Group and national level Logistics teams only activate when they are, or are likely to be, required to coordinate the Logistics function, or to fulfil Resource Requests from lower levels.

Community is a level of response, made up of numerous organisations and groups. Community-level responses may interact with the CDEM Logistics function in a variety of ways. Community responses are outside the scope of this guideline, as they are in addition to the CDEM response. However, as CDEM responses aim to meet community needs, the community must be factored into all response arrangements and activities.

Relationships between levels

A summary of the relationships between the different CDEM Logistics levels and responsibilities is shown in Table 2-1 below. Note that:

- costs lie where they fall, unless approved by the Controller of another agency or response level who agrees to provide funding
- tasks are prioritised following the direction from that level’s Controller, and
- a lot of logistics activity occurs at incident sites, as this is where the response interacts with the affected population. A lot of this activity may be ad hoc, and/or organised by volunteers and businesses within the community. CDEM planning needs to focus on ways to support and reinforce the affected communities’ response.

Table 2-1 CDEM Logistics responsibilities for different levels of response

Processes requests from	Procures resources from	Delivers to	Notes
National level – coordinated through NCMC – directed by National Controller			
<ul style="list-style-type: none"> • ECCs • national agencies 	<ul style="list-style-type: none"> • national agencies • unaffected CDEM Groups and local authorities • directly from suppliers • international assistance (see note) 	<ul style="list-style-type: none"> • National Assembly Areas • CDEM Groups • territorial authorities (at ECC request) • incident site (at ECC request) 	International government and NGO assistance is only sought following approval from Cabinet. This process is managed through the NCMC.
Regional level – coordinated through ECC – directed by Group Controller			
<ul style="list-style-type: none"> • local EOCs • regional agencies • NCMC 	<ul style="list-style-type: none"> • National Assembly Areas • directly from suppliers • own internal resources • regional agencies 	<ul style="list-style-type: none"> • CDEM Group Assembly Areas • territorial authorities • direct to incident site (at EOC request) 	Resources may be procured from outside the CDEM Group’s boundaries, but NCMC approval is required when this involves critical resources.
Local level – coordinated through EOC – directed by Local Controller			
<ul style="list-style-type: none"> • ICPs • local agencies • CDEM Group • community 	<ul style="list-style-type: none"> • CDEM Group • own internal resources • local agencies • directly from suppliers • community 	<ul style="list-style-type: none"> • Local Assembly Area • direct to incident site • Civil Defence Centres • community groups 	Resources may be procured from outside the territorial authority’s boundaries, but the ECC must be informed when this involves critical resources.
Incident – coordinated through the incident control point– directed by Incident Controller			
<ul style="list-style-type: none"> • responder teams • community 	<ul style="list-style-type: none"> • EOC • own internal resources • local agencies • directly from suppliers • community 	<ul style="list-style-type: none"> • end user • incident level staging area • community groups 	The physical CDEM response occurs at this level. Incident sites include any place where specific individual response activities are carried out.

The CDEM Logistics workflow is shown in Figure 4 below.

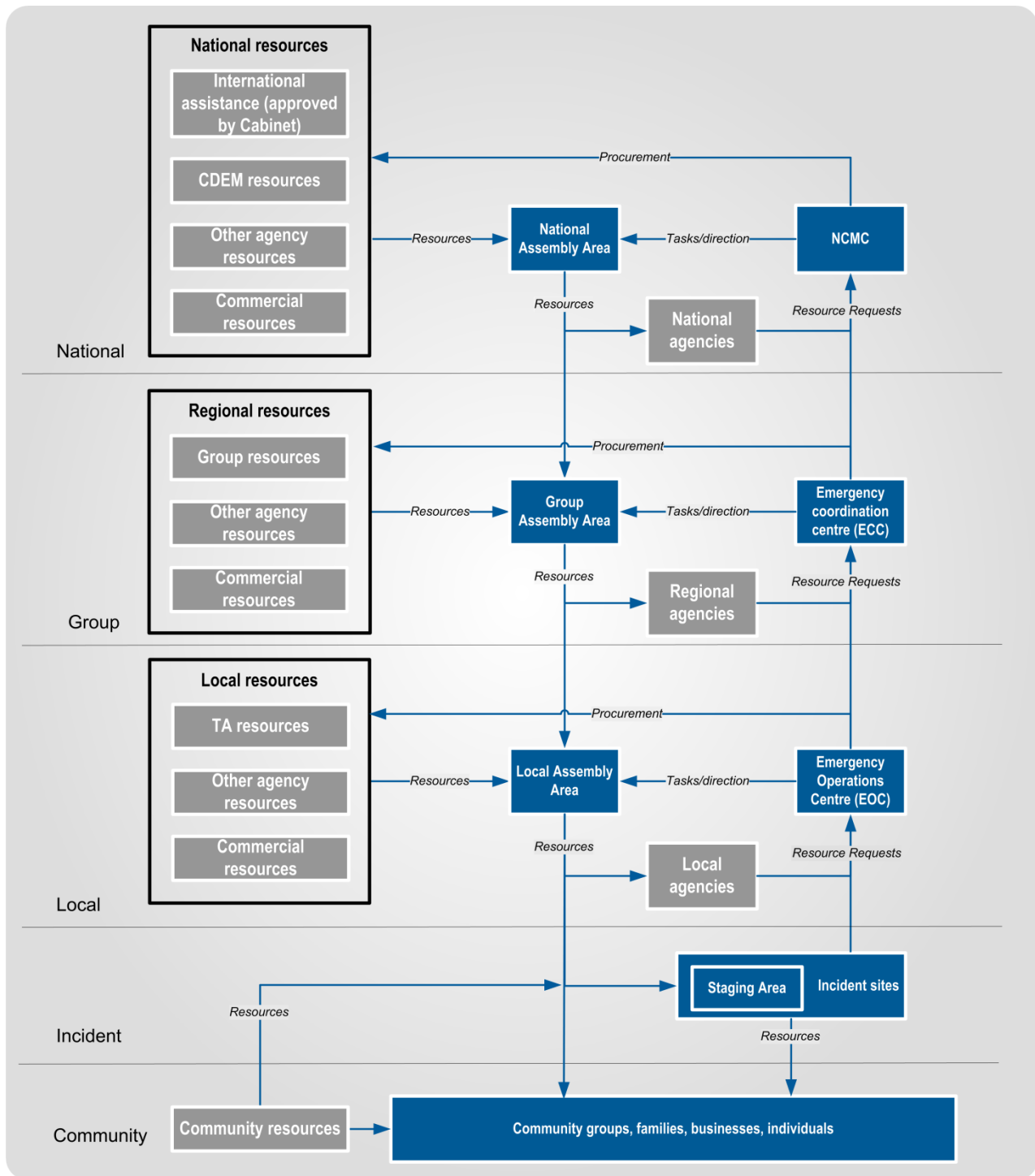

Figure 4 The CDEM Logistics workflow

Notes:

1. Resources can bypass Assembly Areas and response levels, and be delivered direct to the end user. If Assembly Areas are not established, resources could go to the coordination centre for holding, or should go direct to the end-user.
2. Community resources can be used by official responders, particularly at the local and incident response levels, normally by negotiation with community groups.

2.3 Logistics and CIMS

The Coordinated Incident Management System (CIMS) is a proactive incident management framework, used by New Zealand agencies when responding to emergencies. CIMS is intended to achieve effective response management and multi-agency coordination for all emergencies, regardless of hazard, size, or complexity. It aims to coordinate separate agency operations into a single, unified response. CIMS:

- provides the model for command, control, and coordination of emergency responses across agencies, and
- is used by Police, Fire Service, Ambulance, New Zealand Defence Force (NZDF), CDEM organisations, and many government agencies.



Seven main functions in CIMS

CIMS is detailed in the *Coordinated Incident Management System (CIMS) Manual, 2nd edition*, available from the CDEM website www.civildefence.govt.nz by searching for the document name.

CIMS has seven main functions (see Figure 5 below):

- **Control:** responsible for coordinating and controlling the response element. It sets priorities and objectives.
- **Intelligence:** responsible for the collection and analysis of response information, especially relating to the status, hazards, and context of the emergency.
- **Planning:** responsible for developing and updating Action Plans, and other plans such as long-term or contingency plans.
- **Operations:** responsible for the day-to-day coordination of the response, detailed task planning, and the implementation of the Action Plan. It is also responsible for volunteer coordination, and liaising with other agencies.
- **Logistics:** responsible for providing and tracking resources to support the response and the affected communities, and providing logistics advice to other CIMS functions.
- **Public Information Management (PIM):** responsible for informing the public, media liaison, and community liaison. They may also issue warnings and advisories.
- **Welfare:** responsible for coordinating and delivering emergency welfare services and resources to affected individuals, families/whānau, and communities.

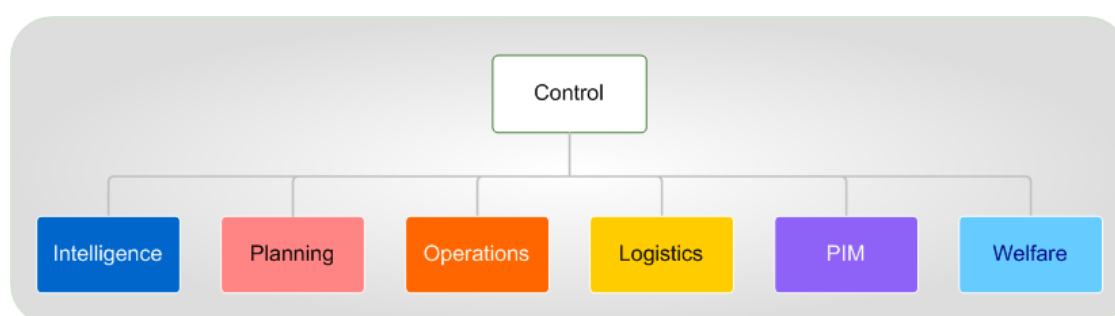

Figure 5 The main functions of CIMS

Logistics structure

Like the other functions within CIMS, Logistics is made up of a number of sub-functions, detailed in Section 3 [The Logistics sub-functions](#) on page 19. The Logistics sub-functions are the activities that address the core responsibilities of Logistics. A Logistics team in a response element should cover these functions, although some sub-functions may not be applicable. Depending on the circumstances, several sub-functions may be grouped together for a single person or team to be responsible for.

Logistics staff are free to develop a team structure based on their required outputs and available resources, rather than having to strictly adhere to one based on Figure 6.

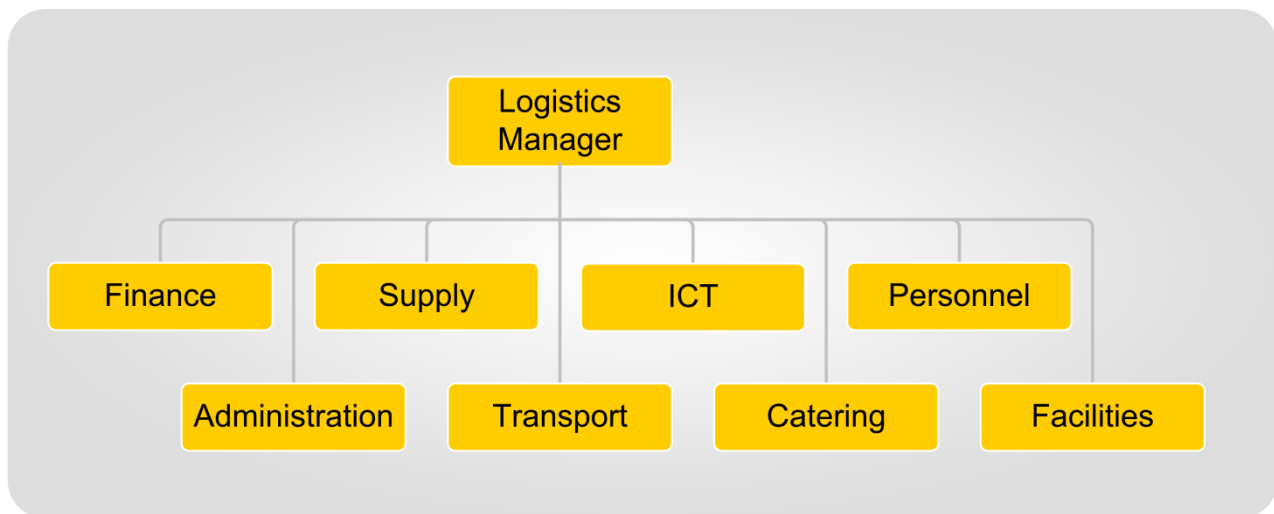

Figure 6 Logistics sub-functions

Centre and field Logistics

Centre Logistics is carried out at coordination centres, and usually does not involve physically handling resources. Field Logistics is the physical provision of logistics support to the responding agencies, and is often based at Assembly Areas and Staging Areas. See Appendix A [Centre and Field Logistics](#) on page 73 for more information.

Key relationships

Constant effective communication is extremely important. Logistics Managers and staff at all levels need to contact their counterparts at other coordination centres to discuss and resolve any issues. Visits to other coordination centres and Assembly Areas will allow faster resolution of problems and a greater understanding of conditions within other response elements.

The key CDEM response relationships for Logistics staff in ECCs and EOCs are shown in Table 2-2 and Table 2-3 on the next pages.

Table 2-2 Response relationships for Logistics in an ECC

EMERGENCY COORDINATION CENTRE	
Within the ECC	
CDEM Group Controller	Logistics staff must understand the objectives and intentions of the Group Controller, so that their efforts help accomplish them.
Other CIMS functions in the ECC	Logistics supports the other functions, and coordination is required between their activities to ensure this is provided in a timely manner. Likewise, other functions must understand the constraints and timeframes that Logistics works to, preventing unrealistic expectations. Logistics must be integrated into all planning activities, including task planning by Operations.
With the regional response level	
Other activated ECCs	Interactions with other Logistics teams at the regional response level include coordinating procurement of resources, sending Resource Requests to each other, and coordinating the use of existing resources (e.g. sequential use of a specific item of heavy plant). The NCMC should be informed of any such action, and may coordinate it, especially if this involves a critical resource.
Regional response agencies and NGOs	Response agencies and NGOs are both potential sources and requesters of resources. ECC Logistics need to know where the agencies and NGOs are based, their level of activation, and who the appropriate contacts are for Logistics. Agency liaison officers will be useful in determining this.
Regional businesses	Where resources aren't readily available from other response agencies, businesses may be approached. For resources that are needed in short timeframes, in large quantities and/or frequently, it may be useful to negotiate pre-existing contracts or Memoranda of Understanding. Any agreements need to include the timeframe, the quantities, and an agreed price.
With the local response level	
EOCs in the CDEM Group	Effective links with EOC Logistics teams are critical in ensuring that effective support is being provided. Regular visits and phone conferences may be needed to ensure ECC Logistics staff understand the needs of their peers at the local and incident response levels.
With the national response level	
NCMC Logistics	NCMC Logistics helps provide access to resources from outside the region. ECC Logistics needs to be able to verify requirements, coordinate deliveries, and discuss upcoming requests. Resource Requests are approved by NCMC Operations.
National Assembly Areas	Resources are drawn from National Assembly Areas (where these have been established), and ECC Logistics need to know where the Assembly Area is located, the communication arrangements with it, and the Assembly Area's capabilities. Dispatch of resources is approved by NCMC Logistics.

Table 2-3 Response relationships for Logistics in an EOC

EMERGENCY OPERATIONS CENTRE
Within the EOC
<p>Local Controller EOC Logistics staff must understand the objectives and intentions of the Local Controller, so that their efforts help accomplish them.</p>
<p>Other CIMS functions in the EOC Logistics supports the other functions, and coordination is required between their activities to ensure this is provided in a timely manner. Likewise, other functions must understand the constraints and timeframes that Logistics works to, preventing unrealistic expectations. Logistics must be integrated into all planning activities, including task planning by Operations.</p>
With the local response level
<p>Other activated EOCs Interactions with other Logistics teams at the local response level include coordinating procurement of resources, sending Resource Requests to each other, and coordinating the use of existing resources (e.g. sequential use of a specific item of heavy plant). The ECC should be informed of any such action, and may coordinate it, especially if this involves a critical resource.</p>
<p>Local response agencies, community groups, and NGOs Response agencies, community groups, and NGOs are potential sources and requesters of resources. EOC Logistics need to know where the agencies, community groups, and NGOs are based, their level of activation, and who the appropriate contacts are for Logistics. Agency liaison officers will be useful in determining this.</p>
<p>Local businesses Where resources aren't readily available from other response agencies, businesses may be approached. For resources that are needed in short timeframes, in large quantities and/or frequently, it may be useful to negotiate pre-existing contracts or Memoranda of Understanding. Any agreements need to include the timeframe, the quantities, and an agreed price.</p>
With the incident response level
<p>ICPs reporting to the EOC Effective links with ICP Logistics are critical in ensuring that effective support is being provided. Regular visits and phone conferences may be needed to ensure EOC Logistics staff understand the needs of their peers at the incident level of response.</p>
With the community
<p>EOC Logistics may deliver to or procure resources directly from the community. Liaison and communication with community groups and volunteer organisations will help to coordinate support to and resources from these groups.</p>
With the regional response level
<p>ECC Logistics ECC Logistics helps provide access to resources from outside the area. EOC Logistics needs to be able to verify requirements, coordinate deliveries, and discuss upcoming requests. Resource Requests are approved by ECC Operations.</p>
<p>Group Assembly Areas Resources can be drawn from CDEM Group Assembly Areas (where these have been established). EOC Logistics need to know where the Assembly Area is based, the communication arrangements, and the Assembly Area's capabilities. Dispatch of resources is approved by ECC Logistics.</p>

Logistics tasks carried out by other CIMS functions

Control, Operations, Planning, PIM and Welfare carry out some logistics tasks.

Control

Control's responsibilities for logistics include:

- designating which resources are critical, and therefore need authorisation prior to issuing by the Logistics function
- approving purchasing authorities and limits
- ensuring the response stays within prescribed resource and budget delegations and limitations
- overseeing Resource Requests from the coordination centre (especially for critical resources or those involving significant expenditure)
- prioritising response operations and corresponding resource use, and
- approving siting of Assembly Areas.

Operations

Operations' responsibilities for logistics include:

- control of critical resources within the respective level of response, including approving any requests to use them
- forecasting resource needs for short and medium-term response operations (see 4.1 [Resource assessment](#) on page 33)
- setting the priority of outgoing Resource Requests
- gaining resources from local response agencies through liaison officers (primarily personnel, equipment, and facilities)
- defining their needs for the ICT plan
- coordinating information and response activities with lifeline utilities
- providing the numbers of personnel requiring catering and accommodation, where these are to be provided, and any special meal/accommodation requirements, and
- where traffic control measures are in place along a road or at a transport node (see Appendix O [Transport background information](#) on page 114), set movement priorities and approve any request to travel along or through the restricted route.

Planning

Planning's responsibilities for logistics include:

- forecasting resource needs for long-term response operations (see 4.1 [Resource assessment](#) on page 33), and
- ensuring that Logistics personnel are involved in every step of the planning process.

PIM

PIM responsibilities for logistics include forecasting resource needs for community liaison activities.

Welfare

Welfare's responsibilities for logistics include forecasting resource needs for long-term welfare activities (see 4.1 [Resource assessment](#) on page 33).

2.3.2 The CDEM Emergency Management Information System (EMIS)

The Emergency Management Information System (EMIS) is used by CDEM organisations to record information and maintain situational awareness during emergency response.

Logistics personnel can get information about training, and access to the system from the EM Officer or GEMO Manager.

Logistics use of EMIS

The Logistics team can use EMIS to carry out various information management tasks, including:

- recording resources in a combined database
- accessing information to maintain situational awareness
- storing documents
- tracking tasks and resources
- creating and processing Resource Requests, and
- recording and assigning messages.

Logistics staff should become familiar with the logistics pages in EMIS, in particular the 'Supply and Transport' and 'Finance' pages.

Main features of EMIS

The main features of EMIS are that it:

- provides a common operating tool for all CDEM stakeholders in New Zealand
- is web-based, so users can access the system anywhere the web is available
- is highly available and provided with redundancy, with multiple internet connections to the main site in Wellington and the disaster recovery site in Auckland
- provides MCDEM, CDEM Groups, and local authorities with their own portal with the ability to create 'event sites', manage and maintain base data, and assign user rights as required within their own secure website structure
- enables all users to see information from within their site and relevant information from other sites
- provides real-time recording and tracking of data
- includes a full search capability, and
- allows for the creation of standardised reports such as Action Plans, Situation Reports, resource status information, Resource Requests, maps, and welfare information.

SECTION 3 THE LOGISTICS SUB-FUNCTIONS

This section describes the CDEM Logistics sub-functions of:

- Logistics Management
- Finance
- Supply
- Information Communications Technology (ICT)
- Personnel
- Administration
- Transport
- Catering, and
- Facilities.

3.1 Summary

The CDEM Logistics sub-functions are summarised in Table 3-1.

Table 3-1 Logistics sub-functions

Sub-function	Description
Logistics Management	Coordinates and manages the other Logistics sub-functions, and provides logistics advice to the Controller.
Finance	Tracks response costs, pays accounts and invoices, provides authorised cash advances, and audits financial accounts.
Supply	Procures resources, tracks Offers of Assistance, and provides supply information to the Planning function. Supply at an Assembly Area is responsible for receipt, storage, inventory tracking, and loading of supplies and equipment.
Information Communications Technology (ICT)	Establishes and maintains the communications links and information technology networks in the response element. ICT receives messages, logs them, and then distributes them to relevant functions, and sends radio or courier messages on behalf of other functions.
Personnel	Manages human resources, including registering and training response personnel (including spontaneous volunteers), and payment of staff (where required).
Administration	Arranges clerical support, cleaning, maintenance, pool vehicles and record-keeping (especially key response documents), particularly in a coordination centre.
Transport	Provides transport and equipment maintenance. Transport works with Supply to transport resources to where they are needed.
Catering	Provides meals and drinks to response personnel.
Facilities	Secures buildings and land for use by response personnel, and maintains these throughout the response.

3.2 Logistics Management

Logistics Management coordinates and manages the other Logistics sub-functions. Its responsibilities include:

- analysing tasks assigned to Logistics
- tasking Logistics teams and ensuring completion of those tasks
- determining the composition of the Logistics team based on response needs
- overseeing logistics activities
- providing advice on logistics, especially to the Controller and other members of the IMT
- reporting, often using logistics-specific systems
- managing the resources used by Logistics
- communicating with Logistics Managers in other coordination centres
- ensuring team welfare and shift management
- ensuring effective communication among Logistics personnel, and
- determining the purchasing phases (reactive, emergency, or accelerated – see Appendix N [Procurement phases during an emergency](#) on page 111).

The Logistics Management team includes:

- the Logistics Manager in the coordination centre
- Assembly Area Managers
- secondary/alternate Logistics Managers, and
- other personnel assigned to Logistics Management tasks.

3.3 Finance

Finance is responsible for organising finances to support response activities, and is based at the coordination centre.

Finance responsibilities include:

- paying approved invoices
- maintaining a purchase order/invoice tracking system
- preparing cash advances to response personnel (approved by the Controller)
- auditing
- tracking costs and expenditure for response activities
- procuring insurance and compensation for responders
- setting up delegations and cost centre codes (approved by Controller and administering authority), and
- assisting in preparing claims to central government for the reimbursement of qualifying response costs.

Using BAU procedures

Finance should make maximum use of business as usual (BAU) financial processes and systems, with some specific measures made in advance.

Following BAU processes makes best use of:

- personnel trained and experienced in the use of these systems
- familiarity across the response element with finance procedures
- tested procedures for expenditure, budgeting and auditing, and
- the common understanding across the organisation of how funds are sourced, spent, and tracked.

If BAU processes are not available, EMIS provides some documentation such as purchase orders and purchase order summaries.

Government financial support



Government financial support can be made available during and after an emergency, at the discretion of Cabinet.

The processes and available support are in the *Guide to the National CDEM Plan*. This includes CDEM expense claims, and compensation for costs, damage, or loss. The claims process is detailed in Appendix D [Government financial assistance](#) on page 82.

Finance personnel

The preferred people to work in the Finance team are the finance department personnel from the respective local authorities.

The Finance Manager and/or team leaders can be appointed to head this team and should also be considered for other appointments, including that of Logistics Manager.

3.4 Supply

Supply is responsible for requesting, procuring, storing, issuing, tracking, loading, and disposal of supplies. Refer to Section 4 [Resource processes](#) on page 33 for information about these processes.

Supply uses the 'Supply and Transport' and 'Finance' pages in EMIS.

Supply personnel are based at the coordination centre and Assembly Areas.

Using BAU procedures

Supply should use their local authority's BAU procurement process (modified if necessary) during response. This means personnel are using established procedures and systems, and the BAU procurement team can provide advice, personnel and support.

If the BAU processes are not available, EMIS provides limited documentation such as purchase orders and purchase order summaries to assist with managing procurement.

Coordination centre Supply responsibilities

Supply responsibilities at the coordination centre include:

- processing Resource Requests from response agencies, other coordination centres and incident sites including:
 - receiving and recording the requests
 - clarifying and verifying the information is accurate and there is a need
 - filling requests from available resources if possible
 - forwarding requests to ECC/NCMC when the resources are proving difficult to source or capacity is limited
- procuring resources where these are authorised and available, and raising purchase orders
- assigning tasks to Field Supply personnel, to meet approved Resource Requests
- receiving inventory information from Field Supply personnel
- providing advice to Logistics Manager and other relevant coordination centre personnel on supply matters, including:
 - resource types held and stock levels
 - procurement issues
 - delivery timeframe
- recording and processing all Offers of Assistance, including:
 - recording the Offer
 - acknowledging the Offer with the provider
 - matching Offers against Resource Requests
- accepting offers for needed resources, and arranging delivery
- providing advice to the Controller on donated goods, and
- confirming with Field Supply personnel that goods delivered match the invoice(s).

Field Supply responsibilities

Field Supply responsibilities include:

- receiving and managing delivered resources
- collating, loading and forwarding resources to responding agencies, in accordance with approved tasks from the coordination centre
- informing Logistics personnel at the coordination centre of inventory levels and conditions, and
- verifying invoices/packing slips/delivery dockets by matching these with the goods and services received.

Supply relationships

Figure 7 on the next page shows the relationships between Supply in a coordination centre and in the field.

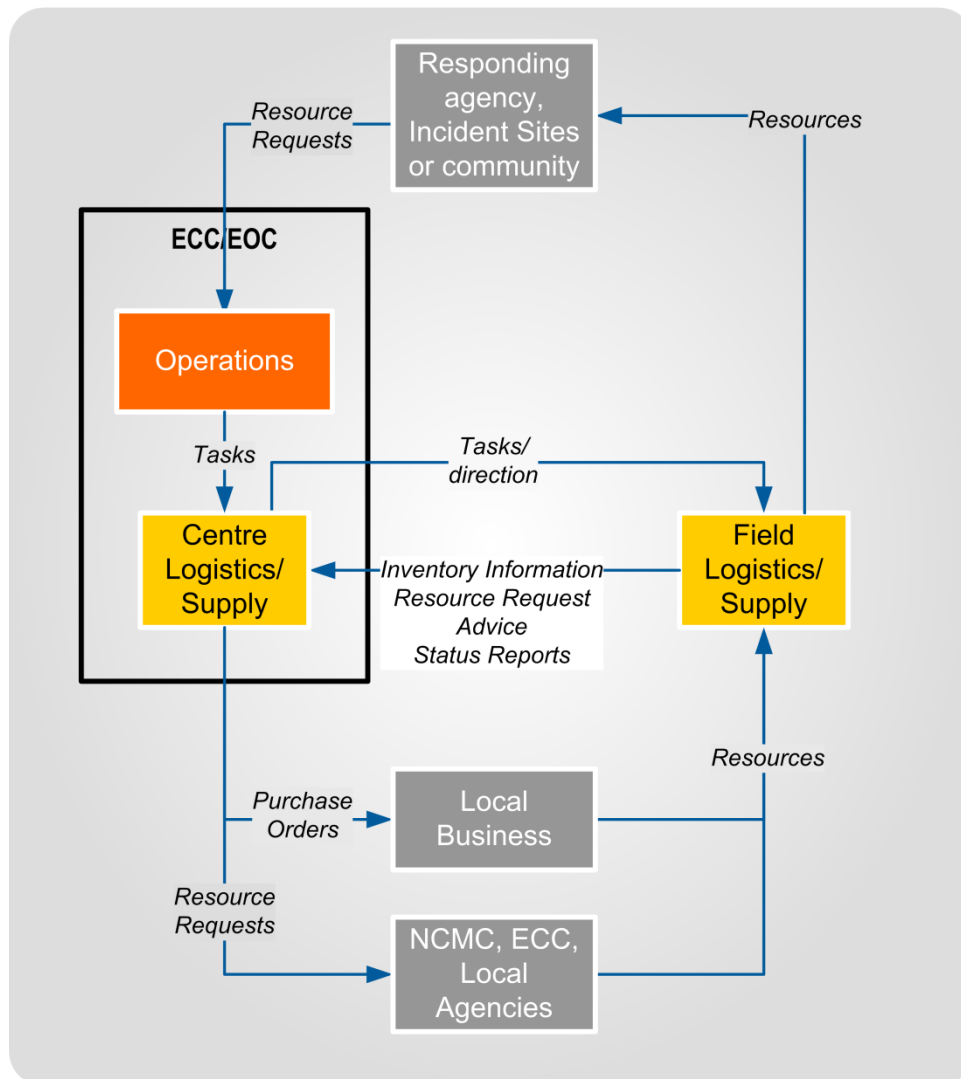

Figure 7 Supply relationships at a coordination centre

Transport and Catering

Supply is responsible for Catering and Transport if they are not established as separate teams.

3.5 Information Communication Technology (ICT)

ICT is responsible for providing the means for response elements to communicate with each other via computer, radio, or phone (landline, cellular, or satellite). ICT for the affected population is the responsibility of the telecommunications sector and is outside the scope of this function.

ICT is usually located at the coordination centre, and closely linked with the Controller. A Controller and coordination centre cannot perform effectively without communications.

Some ICT personnel may be attached to larger emergency level response elements or to an Assembly Area, particularly if normal landline and cellular networks are not functioning (e.g. a radio team at a major road operation).

Using BAU procedures

Maximum use should be made of the ICT processes and systems used by the agency, with some specific measures made in advance.

Following BAU processes makes best use of:

- personnel trained and experienced in the use of these systems and current ICT architecture, and
- familiarity across the response element with ICT systems and procedures.

ICT responsibilities

ICT responsibilities include:

- developing an ICT plan to ensure the coordination centre can communicate with all major response elements, including subordinate EOCs, incident sites, and Assembly Areas
- determining the equipment required to implement the ICT plan, and requesting its procurement through Supply
- installing and maintaining communications equipment such as computers, networks, and antennas. (The telecommunications lifelines utilities sector will maintain and repair any networks and equipment that belong to them)
- sourcing/providing trained operators to enable communications networks to function
- providing technical advice on the employment of communications devices to the Logistics Manager and Controller, and
- maintaining a register of ICT equipment.

ICT responsibilities may also include receiving, logging, and distributing messages (including by courier and radio). Some agencies may assign this to the Operations function.

ICT plan

Developing an ICT plan will involve the following:

- determining the communications requirements for the responding agencies, in terms of number of response elements to be supported and the types and capacity of communications needed. The priority and communications needs will be detailed by Operations.
- assigning available personnel and equipment resources to the responding agencies, and
- for radio networks, determining frequencies to be used, establishing call signs, confirming the Network Control Station (which call sign has primacy) and any procedures to be followed.

This should be detailed in the *Logistics Appendix in the Action Plan*.

3.6 Administration

Administration carries out administrative tasks to support the coordination centre. It is usually activated to support ECCs and EOCs, and occasionally at larger ICPs or Assembly Areas.

This team's responsibilities include:

- providing clerical support to the coordination centre
- overseeing the development of the staff roster, in consultation with the Response Manager and function managers
- working with other Logistics sub-functions to ensure the following for the coordination centre/Assembly Area they are based at:
 - catering (with Catering or Supply)
 - cleaning and maintenance (with Facilities)
 - use of coordination centre pool vehicles
- record-keeping (with advice from ICT and Control), particularly of key response documents (see section 5.3.8 [Archiving](#) on page 60)
- returning the coordination centre to its original state following deactivation of the response, and
- other administrative tasks as directed by the Logistics Manager.

3.7 Transport

Transport is responsible for moving personnel and other resources, enabling other functions, sub-functions, and response elements to carry out their responsibilities. If a Transport team is not established, then Supply is responsible for this sub-function.

Transport personnel based in the coordination centre carry out transport planning and coordination, and provide advice to the Logistics Manager. Transport personnel based at the Assembly Area load and unload vehicles (with Supply), plan transport tasks in detail, and drive vehicles. Transport responsibilities include:

- detailed task planning for transport
- providing transport, maintenance, and site security advice to the Logistics Manager
- managing the relationship with commercial transport companies used in the response
- developing a Transport plan (if required)
- providing transport for personnel/resources, including pool vehicles
- refuelling vehicles and equipment (where there are no pre-existing arrangements, such as vehicle fuel cards)
- organising maintenance (where this is not done by equipment providers), and
- site security (usually through contracted security guards).

'Ground Support' is a term sometimes used to describe the Transport sub-function.

Transport background information

Appendix O [Transport background information](#) on page 114 has additional background information about transport, including descriptions of:

- heavy and light transport
- the main types of vehicles used for passengers and freight, and
- transportation nodes.

Transport into ECC or EOC

Where a higher response level has procured a resource, responsibility for organising transport to move that resource into an area sits with that higher response level, unless otherwise agreed. An ECC or EOC may arrange transport into their area themselves provided:

- they have procured the resource(s)
- it has been discussed and agreed with the next response level (NCCM /ECC), and
- this is likely to be a faster result.

Control

Transport in any area will be under the control of multiple agencies, and response agencies are likely to have their own vehicles. This is managed by ensuring that each specific transport resource is controlled by only one agency, to prevent the assignment of conflicting tasks.

Transport resources (vehicles and drivers) can be attached when the receiving agency does not have sufficient resource to meet its operational responsibilities. This is to provide a short-term boost in transport capability and capacity (e.g. NCCM attaching NZDF vehicles to a CDEM Group during a flood response).

Attached Transport refers to Transport resources that are:

- owned/commanded by one agency, and
- allocated to another response level or agency which then controls the tasks for those resources.

The costs for operating transport may be covered by either party, and will require agreement prior to it being attached. The owning agency retains command of the transport resources, and will require them back. When this is, the conditions under which it may be taken back, and the lead-time should be determined in advance.

Tracking Transport tasks

Tracking Transport tasks is best done in a spreadsheet, EMIS list, or whiteboard. See Appendix E [Content for forms](#) on page 88 for the information that needs to be included in Transport tracking records. If using a whiteboard, ensure the information is recorded on paper or by camera, before significant changes are made.

Driving hours



Drivers of commercial and heavy vehicles are responsible for tracking their driver hours. Transport is responsible for ensuring drivers do not exceed their hours, and remain legally compliant and fit to operate their vehicles.

There are limited grounds for drivers to exceed legal driving hours requirements. These are explained on the New Zealand Transport Agency website, www.nzta.govt.nz, under the 'Worktime and Logbooks Rule 2007'.

In summary:

- During a state of emergency declared under the *CDEM Act 2002*, a driver may extend work time hours if the driver can provide evidence that they were directed or authorised to do so by a Controller, or by any member of the Police, or any other person acting under their authority, to carry out emergency response work.
- As soon as is practicable, a driver must record in their logbook the reason for exceeding work time requirements, and any additional hours, arising from emergency response work.
- Emergency service drivers may work beyond standard work time limits on a call-out, but must return to their base immediately for their required break.
- Essential service drivers can extend their work time hours if requested by a manager of the relevant authority to restore essential services.
 - Essential service drivers include drivers who work for road controlling authorities, territorial authorities, lifeline utilities, and people working on emergency works to stabilise land or reduce risk to persons or property.
 - They will need to record the details in their logbook. The person requiring a driver to extend their work time hours must record and retain the name of the driver, the hours worked, and the situation requiring the variation details for 12 months.
 - The same rules apply for a State of Emergency.
- Where there are unavoidable delays due to a state of emergency or an emergency, drivers may complete their journey, but must note this in their logbooks. This is a defence, not an exemption.

Wherever possible, a Transport team should not require drivers to exceed their legal driving requirements. If planning indicates that drivers will be required to consistently exceed normal work time limits, the Logistics team should request more drivers.

Certification of vehicle operators

When transport operators (drivers, pilots, crew etc.) accompany a vehicle, the owner of the vehicle is responsible for ensuring the operators have the appropriate licences and certification.

If Logistics procures vehicles separately without operators, Logistics is responsible for ensuring the operators have the appropriate licences and certification.

Supporting equipment

Trucks, barges, boats, and some helicopters may require the supporting equipment as listed in Table 3-2 below.

Table 3-2 Transport equipment and facilities

Vehicle	Required equipment and facilities
Land transport, including trucks	Loading/unloading bays Forklifts and/or cranes for loading and unloading Rough-terrain forklifts will be needed if the loading area is not hardstanding (concrete, asphalt), and the trucks don't have cranes or swing-thru equipment
Barges: self-propelled or towed	Tow-craft if required Forklifts and/or cranes to load and unload Boat ramps, marinas, or wharves preferred for landing If using beaches to land: matting, planking or similar to enable wheeled vehicles to move on and off the vessel Area to crossload to/from other transport
Large boats or ships	Wharves, piers and other docking facilities to load and unload Cranes for loading and unloading larger loads Area to crossload onto other transport
Helicopters	Cargo nets and cables for underslung loads Controlled helipads
Fixed wing aircraft	Runways, with refuelling, loading, and unloading areas Appropriate equipment and containers for rapid load/unload and safe transit Safe and secure waiting and support areas for passengers

Fuel

Transport planners need to ensure that there is ready access to fuel of the appropriate types at all times.

The *National CDEM Fuel Plan* details the actions that will be taken during fuel shortages through a CDEM emergency response. This includes the prioritisation of response agencies' supply. Logistics will be informed when the *National CDEM Fuel Plan* is activated, and personnel should become familiar with it.



The public version is available on the MCDEM website www.civildefence.govt.nz, by searching for the document name. The full version is held by CDEM GEMOs and fuel companies. Refer also to CDEM Group Plans, and to Group Fuel Plans.

3.8 Catering

Catering is responsible for the provision of prepared food and drinks for the responding agencies and, in some circumstances, communities. Catering will be required when a response lasts more than 6 hours, and the responders are not self-supporting. The Catering sub-function is based at the coordination centre. It is carried out by Supply if Catering is not established. Operations, Planning, and Personnel provide information to Catering regarding how many personnel require feeding, where they are to be fed, and what type of meals to prepare.

Catering responsibilities include:

- developing a catering plan, based on personnel figures provided by Operations, Planning, and Personnel, and the availability of caterers
- arranging for the provision of meals (following the catering plan) through:
 - commercial caterers
 - vouchers or allowances issued to response personnel
 - non-government organisations such as the Salvation Army, or
 - a catering team attached to the response (such as an NZDF team)
- ensuring appropriate hygiene measures are followed
- setting up any required equipment and facilities (with Supply and Facilities)
- arranging transport of meals (with Transport), and
- liaising with health and food safety authorities as required.

Catering is not responsible for ingredients (Supply), or provision for affected communities (Welfare), unless support to the community is a specific task given as part of the response.

Meals supplied by Catering

Meal provision requires a kitchen, refrigeration, trained personnel, washing facilities, and the ability to procure and prepare ingredients in the required quantities. This is normally outsourced due to the complexity of safely and efficiently preparing meals for large numbers of responders.

Where catering teams and facilities are part of a response, they may be at an Assembly Area, or at a separate facility, depending on what equipment is available. This team works with Supply to procure ingredients, and Transport to deliver meals.

Dining facilities may be established for responding personnel, as it may be easier for them to return for meals rather than be fed at incident sites.

If there are no Catering personnel based at the coordination centre, the Catering Manager at the Assembly Area needs to:

- update the coordination centre Logistics Manager regularly, and
- have access to forecast response personnel numbers, so the Catering Plan can be amended.

Catering plans

Catering plans cover how many meals of which type are to be prepared. Type of meal refers to the method of delivery as well as the way the meal is prepared. An example of a catering plan is shown in Table 3-3 below.

Table 3-3 Example of a catering plan

Date	Breakfast	Lunch	Dinner	Notes
Mon 3 Aug	40 dining room 20 delivered- site 1	10 dining room 10 cut lunch 40 delivered- site 1	50 dining room 10 delivered- site 1	60 personnel Cooked breakfast
Tue 4 Aug	70 dining room 10 vouchers	10 dining room 10 cut lunch 30 delivered- site 1 20 delivered- site 2 10 vouchers	60 dining room 20 delivered- site 2	80 personnel Continental breakfast 4 th meal, 20 delivered, site 2, 11:00 pm
Wed 5 Aug	10 dining room 10 delivered- site 1 10 delivered- site 2 10 vouchers	10 dining room 10 cut lunch 20 delivered- site 2	30 dining room 10 delivered-site 2	40 personnel Cooked breakfast
Thu 6 Aug	10 dining room 30 delivered- site 2	10 dining room 20 delivered- site 2 10 delivered- site 3	30 dining room 10 delivered- site 3	40 personnel Continental breakfast
Fri 7 Aug	30 dining room	30 cut lunch	Nil	30 personnel Response ends 2pm

Fourth meal

When response personnel are working late at night (i.e. later than 11:00 pm), Catering staff should consider providing a 'fourth meal'. This means that response personnel can expect a meal approximately every six hours.

Planning notes

Timing significant meals to occur at shift changes can assist in providing more efficient responses.

Providing packed meals for response personnel to take with them can significantly reduce travel, delivery, and down-time.

3.9 Facilities

Facilities is responsible for sourcing buildings and land for use by responders, and maintaining the facilities.

Provision of emergency shelter or accommodation to the affected population is not part of Facilities role, but Facilities may assist Welfare in providing this.

Facilities personnel may be based at a coordination centre or in an Assembly Area.

Facilities responsibilities include:

- arranging contracts for the use of commercial properties, in consultation with Supply
- on direction from the Controller, establishing:
 - Assembly/Staging Areas
 - other locations, such as an alternative EOC by using existing buildings or constructing temporary facilities with tents, portacabins, portable toilets, etc
- procuring, allocating, and maintaining response personnel accommodation, including ablutions (toilets, showers etc)
- maintaining facilities that are in use by response personnel and agencies
- organising security for facilities that are in use by response personnel and agencies, and
- handing facilities back to their owners following the end of the response, or transferring them to a recovery agency.

Facilities should ensure adequate provision for disabled access and use.

Possible facilities

Possible buildings to use for different functions are given in Table 3-4 below:

Table 3-4 Potential buildings for various functions

Required function	Potential buildings
Coordination centres	Council offices, community halls, emergency services offices
Civil Defence Centres	Community halls/centres, sports grounds, camping grounds, schools
Assembly Areas	Nominated private or commercial premises, appropriate warehouse facilities, sports fields/centres, community halls/centres
Response personnel accommodation	Motels/hotels, camping grounds, hostels, sports grounds (with tents, caravans or campers), private billeting

3.10 Personnel

Personnel is responsible for registering, tracking, and training response personnel (including spontaneous volunteers), and payment of staff. Once volunteers are trained, they become the responsibility of Operations.

Coordination centre personnel

The Personnel team based in a coordination centre during response are responsible for:

- forecasting personnel needs with Planning and Operations, and
- planning training.

Personnel may also be responsible for allocating accommodation to response staff, if this has not been assigned to Facilities.

Assembly Area personnel

Members of the Personnel team may be required at an Assembly Area to supervise and conduct volunteer training. The Assembly Area Personnel team carry out the following:

- registering and inducting response personnel from other areas
- briefing response personnel from other areas and volunteers on the specific health and safety risks in the response
- registering and categorising volunteers, and
- training volunteers and other response personnel.

Staff rolls

The Personnel team maintains a record of the staff who are working on the response, based on registration records, rosters, and (where necessary) reports from other functions. This may also include next-of-kin details.

Staff from other agencies are recorded and tracked by those agencies. If necessary, support agencies may be required to send a daily report on the numbers of staff they have assigned to the response to the lead agency.

SECTION 4 RESOURCE PROCESSES

This section describes the main processes related to resources that are carried out during a CDEM response. They are grouped as shown in Figure 8 below.



Figure 8 Resource processes

These three steps represent “I need it”, “I’ll get it” and “I’ll use it”. In summary:

- Resource assessment is when a need for resources is identified, normally by Operations or Planning, with assistance from Logistics.
- Procurement is the action of obtaining something, and is carried out by Logistics.
- Resource management includes the recording, tracking, storage, issuing, and disposal of procured resources. It is carried out by Logistics.

4.1 Resource assessment

Resource assessment is the first step in managing resources, as shown in Figure 9 below.



Figure 9 Resource assessment

Assessing resource needs is an ongoing process throughout response and recovery. It is carried out by Operations, Planning, and Welfare with input from Logistics.

Resource assessment requires robust analysis of the response/task needs, and all steps need to be completed carefully. Saving time at this step is often a false economy, as a badly defined Resource Request will often be returned for verification. A Resource Request should be considered as an abbreviated business case seeking the expenditure of public funds.

**Resource
definition**

The questions in Table 4-1 may assist in defining needed resources.

Table 4-1 Questions for determining required resources

Question	Description
What are the objectives and the resulting tasks?	Consider the objective(s) that have been assigned to the response element (e.g. town evacuated, stopbank breach repaired, Civil Defence Centre established with showers), and the tasks that are needed to achieve this.
What resources or services are required?	List the resources needed to achieve the tasks, including quantities. Describe them in terms of the desired outcome, with any limitations or requirements. For example, to evacuate a town, the description could be 'transportation to evacuate 100 people from affected area to Smallville CDC, main roads are accessible, pad available for helicopter' rather than specifying buses or helicopters.
What resources do we have that can do it?	Note the resources that are already available, or easily procurable by the CDEM Group/local authority.
What are the resource shortfalls?	Compare the required resources with the available resources. Any shortfalls may become Resource Requests.
When are those extra resources needed?	Consider when these resources are required; some may be needed immediately, some may not be required for several days or weeks.
What is the priority of this task(s)?	The Controller or Operations determines the task's priority. Logistics also need to consider the time the task is due to be started and/or completed, as resources for a low priority task in two days may be more urgent than resources for a high priority task a week away. See Table 4-3 on page 39 for more information.
Are there any special requirements?	Consider if there are any support requirements for the needed resources. These could be fuel types, maintenance or technical support, operator qualifications, or supporting equipment.

Once the resource needs have been properly defined, Operations tasks Logistics to procure the resources that have not already been assigned to the task.

Resources that are held by the response element can be issued to the end-user. Where there are no resources available, Logistics will begin to procure them.

4.2 Procuring resources



Figure 10 Procurement

Procurement:

- is the act of obtaining resources
- begins when a resource need has been identified, and
- ends when the resource has been delivered to the requester.

In the CDEM context, it is the action of gaining resources to assist a response or recovery operation.

Most resources are provided by the responding agencies. However, additional resources may be purchased, hired, or requisitioned by CDEM.

4.2.1 Procurement sources

Once a Resource Request has been received, verified, and approved, Logistics will find suppliers to provide the required good or service.

Procurement sources include:

- local agencies
- Offers of Assistance (commercial and donations)
- local businesses, and
- EOC, ECC, or NCMC.

Each of these sources is discussed in the paragraphs on the next page.

Potential sources may be identified through:

- the requester suggesting a source
- established suppliers, if the request is for a resource that is frequently purchased; there may also be pre-existing contracts or Memoranda of Understanding (MOUs)
- knowledge of staff in the coordination centre
- the local Chamber of Commerce, and
- Yellow Pages/Internet search.

A lack of any local sources is a trigger that should prompt the creation of a Resource Request to another coordination centre.

Local agencies

Local agencies may have resources that they will make available on request during response or recovery.

Consider local agencies first when locating a procurement source, as the resources will be close. Local agencies include:

- local authorities
- emergency services
- government agencies
- non-government organisations/community groups, and
- lifeline utilities.

Requests to local agencies for resources are usually carried out through Operations, as they are responsible for liaising with other agencies.

Offers of Assistance

Offers of Assistance are received at all levels of the response, and may require payment.

It is important to find out from the person making the offer whether the offered resources will be charged for, and if so, what the cost will be. Offers that will be charged are considered to be commercial offers.

All Offers of Assistance from the public, including businesses, must be:

- recorded by Logistics so that Resource Requests can be checked against the list, and
- acknowledged and thanked, even if the offer is unlikely to be accepted.



Offers by members of the public to volunteer need to be forwarded to the Volunteer Coordinator in Operations. This is described in detail in the *Volunteer Coordination in CDEM Director's Guideline*, available at www.civildefence.govt.nz by searching the document name.

Commercial offers are recorded along with any donated offers; the resources offered may prove to be useful but must be clearly recorded as requiring payment. No promises of purchase should be made when receiving the offer.

Once received by Logistics staff, Offers become another resource and are treated accordingly. These resources should be recorded and tracked to ensure they are used in an appropriate manner.

Records of offers should be shared between EOCs, ECCs and NCMC by making lists and sharing them via EMIS or email.

Donations are goods, services and/or money that has been gifted to response agencies by the public and NGOs (including internationally), to assist an emergency response and recovery. Cash donations are preferred, and should be directed to an official disaster relief fund.



Donations are managed by Logistics, following the advice given in *Donated Goods Management Planning Best Practice Guide*, available at www.civildefence.govt.nz by searching the document name.

Local businesses	Resources may also be purchased from local businesses using standard procurement procedures. See 4.2.4 Purchasing on page 40.
Higher response level coordination centres	Resource Requests are used to gain resources from EOCs (by ICPs), ECCs (by EOCs) or NCMC (by ECCs), and may be approved or declined. Resource Requests to other coordination centres are only made when local agencies and businesses are unable to provide the necessary resources.
Political considerations	Offers of Assistance from business and the public made to Ministers, Mayors, CEG Chairs, and other key figures may be passed on to Logistics. These offers need to be raised with the Controller as soon as possible, so that they are aware of them, and can consider the potential use of such offers. Not all such offers are useful, despite the level of political support the offer may have. The Controller decides what is accepted, with advice from the Incident Management Team. If such offers are declined, the Controller may need to be able to explain the decision to the donor and/or politician, preferably with a list of necessary resource requirements.

4.2.2 Resource requests

During readiness, the Logistics Manager needs to ensure procedures for:

- sending Resource Requests, and
- processing received Resource Requests.

Example procedures are given in Appendix K [Resource Request procedures](#) on page 105.

When to issue Resource Requests

Resource Requests are used to access resources:

- externally, for the local authority or CDEM Group, or
- for response agencies to gain resources from CDEM coordination centres.

Resource Requests to the next level of response are generated when all local procurement efforts have failed to produce the required resources in the right quantities. A Resource Request asks another agency (normally an ECC or the NCMC) to expend funds on the behalf of the requesting agency. Expenditure needs to be properly justified and documented.

Need for clarity and checking

Resource Requests must be completed accurately with careful consideration and definition of the need, to avoid unnecessary delays during procurement. The receiving Logistics personnel are likely to be under stress, and may have only basic training and experience. The higher-priority the request, the more care should be taken to ensure it is clear, accurate, and justifiable.

Types of resources



Use the EMIS resource types listed in Table 4-2 below to ensure a common understanding when requesting resources. The resource types are described in greater detail in the *Resource Classification Guide* in EMIS national documents, in the *EMIS Reference Material Library*.

Table 4-2 Types of resources

Type	Description
Personnel	People with specialist skills who will be deployed as individuals.
Teams	A group of people and resources which undertake a specialist or specific function.
Vehicles	Ground-based transportation for people and/or cargo.
Plant	Heavy or construction equipment, often vehicles used for construction, demolition or access. May be self-powered, but usually need to be transported to site.
Aircraft	Air-based transportation, including fixed wing aircraft, helicopters, and drones.
Vessels	Water based transportation for transporting cargo, vehicles, or passengers.
Equipment	Devices used to produce or achieve something that is not consumed in the process. Equipment is usually (but not always) returned after the task is completed.
Supplies	Consumable items, usually obtained in bulk and used as individual or divisible units.
Facilities	Buildings and property for accommodating personnel, storage, or other functions during response or recovery activities.

Resource Request priorities

Resource Request priorities are used to help Logistics determine the order in which resources should be procured. The priority relates to the urgency of the request (whereas critical resources are resources in short supply that are needed for vital tasks).

Use restraint when setting the priority of Resource Requests. If a relatively low-priority Resource Request is given a higher priority, it may prevent the timely procurement of more important resources. Coordination centre Operations are tasked with evaluating the priority of a Resource Request, as they have a more accurate understanding of the operational need. Logistics personnel who receive a request need to take the assigned priority at face value.

The Resource Request is completed by Logistics (with Operations or Planning input) and once completed, goes to Operations at the next level (EOC Logistics to ECC Operations, ECC Logistics to NCMC Operations). Resource Request priorities are defined in Table 4-3 on the next page.

Table 4-3 Priority ratings for Resource Requests

RR priority	Description
High	A resource needed in time, in the correct amounts, and at the right place, otherwise a critical response task (as determined by the Controller) cannot be carried out.
Medium	A resource needed in time, in the correct amounts, and at the right place: <ul style="list-style-type: none"> • so a critical response task (as determined by the Controller) can be carried out without any impediments or delay • otherwise, a non-critical response task cannot be carried out.
Low	A resource that does not meet the criteria for 'high' or 'medium' priority ratings. It is the default rating for Resource Requests.

After Controller's approval for a high priority rating

If Operations or the Controller determines that a resource request has a high priority, the Controller should contact the Controller at the receiving coordination centre to inform them of this, and to discuss the consequences of not receiving the resources. Following this, the Logistics Manager should contact their counterpart at the receiving coordination centre to discuss any issues that may impede delivery.

After Controller's approval for a medium priority rating

If Operations or the Controller determines that a resource request has a medium priority, the Logistics Manager should contact their counterpart at the receiving coordination centre to discuss any issues that may impede delivery.

4.2.3 Procurement considerations

Boundaries

EOCs may freely procure resources from within their territorial boundaries. They may also procure resources from outside these boundaries, particularly where they have standing contracts with external suppliers. Even if they do not, they can procure resources if needed, but they should inform their ECC that this is occurring. Resources outside their boundaries can also be sourced by sending a resource request to the ECC.

ECCs may freely procure resources from within their territorial boundaries. Any resources procured from inside the area of any activated EOCs require liaison and coordination with that EOC. They may also procure resources from outside their boundaries, particularly where they have standing contracts with external suppliers. Even if they do not, they can procure resources if needed, but they should inform the NCMC. Resources outside their boundaries can also be sourced by sending a Resource Request to the NCMC.

The NCMC will seek to only procure resources that are outside the area of any activated ECCs, unless they liaise and coordinate with the activated ECC.

Affected CDEM Groups may request that the NCMC purchases locally to stimulate economic activity. This will be the case when the NCMC is purchasing in bulk on behalf of that ECC.

The NCMC will manage procurement from foreign governments and NGOs, as this requires Cabinet approval. CDEM Groups and local authorities may procure from international commercial providers, but should inform the NCMC of this.

Critical resources

When a coordination centre is seeking to procure critical resources, it should inform its higher level coordination centre (EOC informs ECC, ECC informs NCMC) that this is required. The resource is procured by the higher level and made available to the lower. This will enable procurement of critical resources to be prioritised and coordinated with other coordination centres, to ensure that critical resources are being allocated in the most effective manner.

A coordination centre may be directed to halt its procurement of a critical resource, if there is a higher priority need elsewhere, and not enough of the resource to meet all requirements.

Advantages

The advantages of these provisions are that:

- it can reduce competition between CDEM agencies for the same resources
- each Logistics team can focus on its own area, and can pass responsibility for wider procurement onto another response level
- resources are allocated on a needs-basis rather than a who-bids-first basis, and
- agreed costs may be passed on to the ECC and/or NCMC.

4.2.4 Purchasing

Purchasing:

- refers to buying or hiring goods and services
- in the CDEM response context, this is usually from a business, but possibly other government agencies or NGOs, and
- usually involves payment.

Purchasing rules and delegations

CDEM organisations need to develop purchasing and payment procedures to use in an emergency that are based on their local authority's BAU processes. These need to be followed as closely as practicable as they:

- create a paper trail
- enable personnel to follow familiar processes, and
- allow effective cost tracking.

Changes may be needed because of the short lead-times during an emergency. See Appendix N [Procurement phases during an emergency](#) on page 111.

Ensure that authorisations and delegations for Logistics personnel to make payments are confirmed in writing and within the procurement system itself before an emergency occurs. (Some delegations need to be in the CDEM Group Plan – see [Considerations for delegations](#) on page 59).

Effective documentation is required to ensure accurate and accountable purchasing. Figure 11 below shows a suggested purchasing process designed to maintain accountability. This process is a guide only, as many local authorities will already have robust purchasing processes.

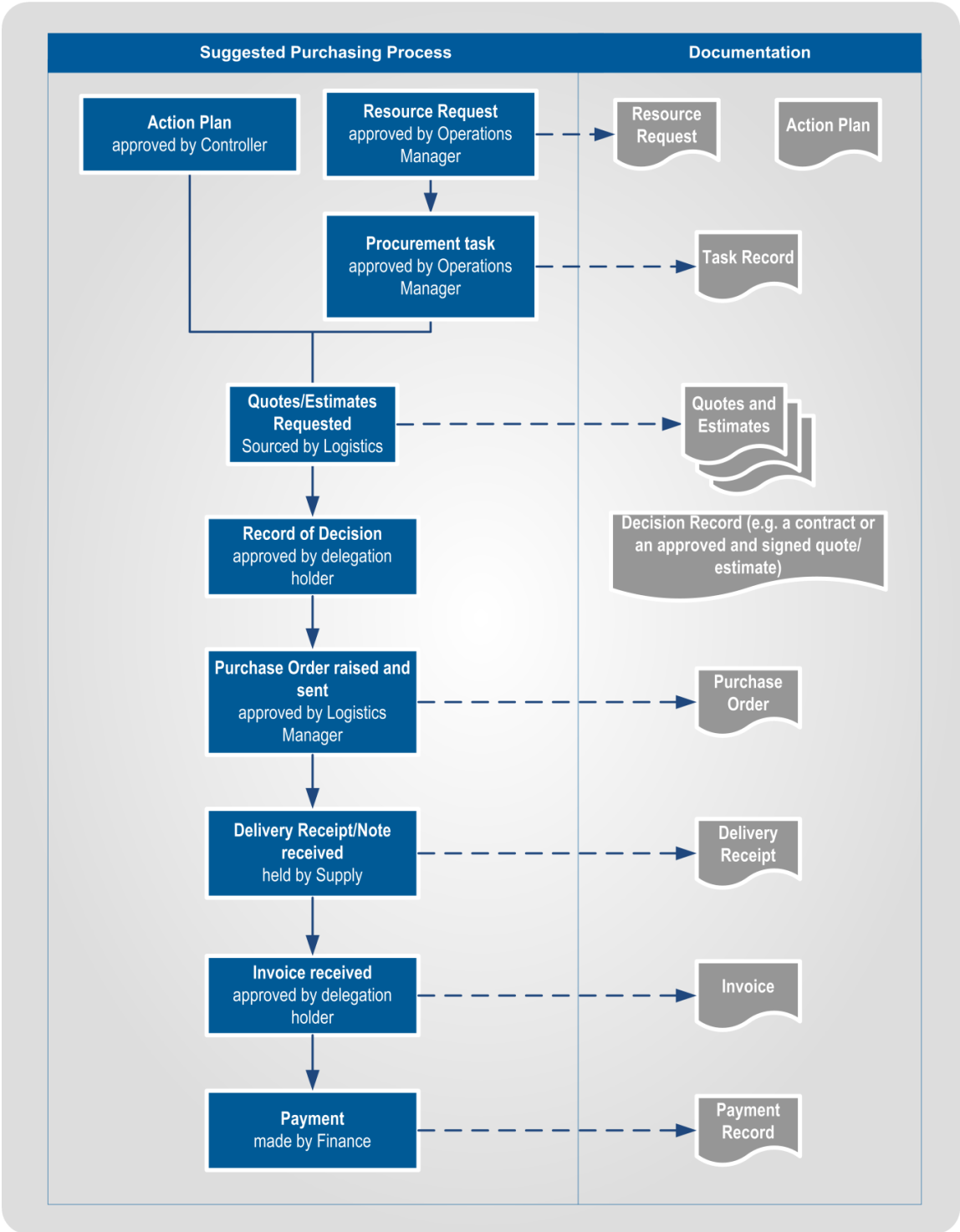

Figure 11 Suggested purchasing process and documentation

Main changes to consider

To ensure BAU finance systems can be used immediately in an emergency, and all costs are captured, consider setting up:

- an abbreviated purchasing process (see Appendix N [Procurement phases during an emergency](#) on page 111)
- preapproved financial delegations (see [Considerations for delegations](#) on page 59), and
- specific cost codes and cost centres for use in an emergency.

Purchasing phases



The Government Procurement Service has issued guidance regarding purchasing during emergency response and recovery, in the *Quick Guide: Emergency Procurement*, available at their website, www.procurement.govt.nz.

It divides the time during and following an emergency into three phases:

- Phase 1 – Immediate response (reactive procurement)
- Phase 2 – Disaster relief (emergency procurement)
- Phase 3 – Post-disaster reconstruction (accelerated procurement).

These are explained in Appendix N [Procurement phases during an emergency](#) on page 111. The Government Procurement Service website describes these in full.

All purchases should have both a purchase order and an invoice, even those made during the immediate response, when purchasing may be reactive.

4.2.5 Requisitioning

A requisition is when a supplier is formally required to provide a resource. Requisitions are made when the resource owner is absent, or when a supplier does not wish to (or is contractually unable to) provide resources.

Only in state of emergency

Requisitioning is only used if a state of emergency is in force, and when all other procurement options have been tried without success.

CDEM personnel can be delegated the power to requisition resources under the *CDEM Act 2002*, sections 90 and 91, when a state of emergency has been declared. Table 4-4 on the next page summarises the relevant sections of the *CDEM Act 2002*. Managers considering requisitioning any resources are advised to read the relevant sections of the Act thoroughly.

Providers may not be able to provide resources due to contractual arrangements, even should they wish to do so. Requisitioning can override these arrangements and allow a supplier to provide a resource.

Powers under the CDEM Act 2002

Table 4-4 on the next page outlines the relevant sections of the *CDEM Act 2002* regarding requisitions. It is a summary only, not legal guidance, and anyone considering the use of these powers should read the Act carefully first.

Table 4-4 Summary of the CDEM Act's provisions relevant to requisitioning

Section of Act	Description
18(2)(f)	<p>General powers of Civil Defence Emergency Management Groups</p> <p>This subsection gives CDEM Groups the ability to "...exercise any other powers that are necessary to give effect to any civil defence emergency management plan." It could be used to authorise the requisition of a resource should the other sections of the Act not be sufficient.</p>
90	<p>Requisitioning powers</p> <p>This is the key section of the Act that provides the powers for requisitioning. Careful reading of the section is advised if its powers are about to be used. The following is a summary of the section:</p> <ul style="list-style-type: none"> • A state of emergency must be in force. • In the opinion of the Controller or a member of the Police, the requisition is necessary for the preservation of human life. • Provided the first two conditions are met, property (defined in subsection 90(2)) may be requisitioned by the Controller, a member of the police or a person authorised by him or her. • The person exercising any power under this section must give the owner of the property a written statement specifying the property that is requisitioned and the person under whose control it will be placed. • If the property owner is not present, an authorised person may assume control and direction of property immediately. A written statement specifying the requisitioned property is given to the owner as soon as reasonably practicable. • The property owner or person in control must provide any reasonable assistance for the effective and safe use of that property. <p>Note that this section refers to property but not to people. It can be used to requisition facilities, supplies, equipment, and transport, but not personnel or teams.</p>
91 (b)	<p>Power to give directions</p> <p>This subsection allows a Controller, a member of the Police, or a person acting under the authority of a Controller or member of the Police, to request any person to prevent or limit an emergency. A state of emergency must be in force. Note that this subsection does not give the power to direct, and it is not an offence under this Act for a person to disregard any such request.</p>
101	<p>Offences in relation to requisitioning</p> <p>It is an offence under the Act for a person to intentionally fail to comply with directions given under s90(2) to provide resources, or to intentionally fail to provide assistance under s90(6).</p> <p>It is a defence if the Court is satisfied that the Controller or member of the Police did not have reasonable grounds to believe that the requisitioning of property was necessary for the preservation of human life.</p>
107	<p>Compensation if property requisitioned</p> <p>This section details how the provision of compensation may be made available in regards to requisitioned property used under section 90, and any loss of or damage to that requisitioned property.</p>
108	<p>Compensation for loss or damage to personal property</p> <p>This section details the provision of compensation that may be payable for loss of or damage to a person's property occasioned by the exercise or performance of work or duties arising from a state of emergency. A person who is requested or directed to stop or take action under section 91 may seek compensation under this section, if they have suffered loss or damage of their property as a result.</p>

Compensation

Compensation is payable for requisitioned property on application, as described in sections 107 and 108 of the *CDEM Act 2002*. Factors that might be considered in determining the amount of compensation include (but are not limited to) the use of the resource, and loss or damage and any insurance payments for loss or damage.

Keep records

Requisitions must be recorded, including any compensation provisions. It is useful to prepare a requisition form that defines the requisitioned resources, time period of requisition, requisitioning person, any support required, and any agreed compensation.

4.3 Resource management



Figure 12 Resource management

Description of resource management

Resource management (see Figure 12 above) covers the receipt, storage, issuing, tracking, and disposal of resources. It is what Logistics does with resources once they have been procured, until they are no longer needed.

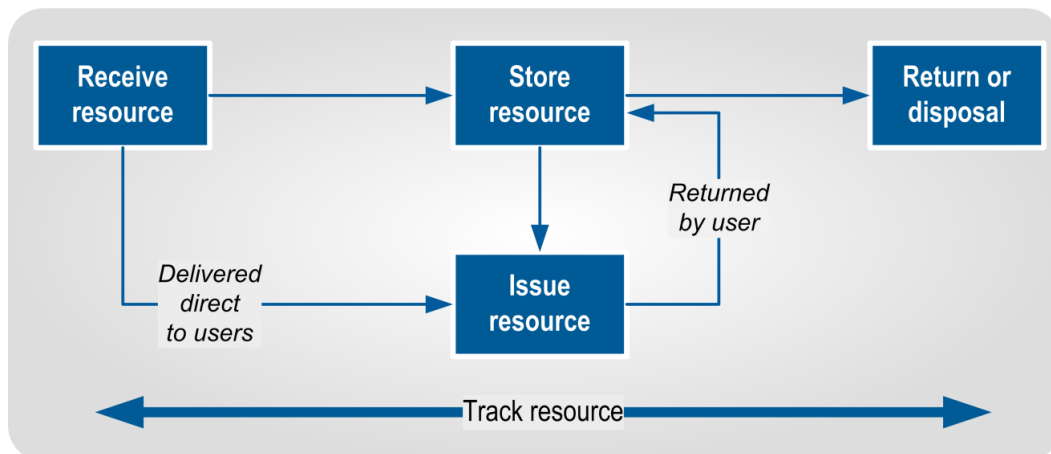

Figure 13 Workflow for managing resources

Resource Management begins when the resources have arrived and are formally received by Supply. Resources are:

- received
- stored (if required)
- issued
- returned to their owners or disposed of, and
- tracked throughout these processes.

CDEM Logistics personnel are responsible for those resources procured by the CDEM Logistics system, for use by the response/recovery operation. Other agencies' resources are the responsibility of those agencies, and will be managed by those agencies' own procedures (for example, Fire Service equipment or Police radios).

4.3.1 Receiving resources

When resources arrive, they need to be formally received and recorded to ensure resources can be located, stored correctly, and forwarded promptly to response personnel. Critical resources must be reported on and updated immediately when their status changes. Accurate receipts also reduce the risk of over and under payments.

Updating records

ECCs/EOCs amend the resource's record in EMIS (creating a new one if necessary) to show it has arrived, under 'Status' and as a comment in 'Notes'.



If EMIS is not available at a coordination centre, a different resource tracking system will be needed. This may be a different electronic system, whiteboards, a spreadsheet or T-Cards. 'T Cards' are a manual system for recording resources, as described in the *National Rural Fire Authority T Cards Guideline*. This can be found on the National Rural Fire Authority website www.nrfa.org.nz by searching for the document name.

If manual records are used, regular reports need to be sent to coordination centre Supply once or twice a day, so they can update EMIS.

4.3.2 Storing resources

Resources that are not issued immediately need to be stored appropriately, considering the factors listed in Table 4-5 below.

Table 4-5 Storage considerations

Storage considerations	Description
Space	How much space is required? Is an Assembly Area required, or can the resources be held in the coordination centre? This will be a prime factor in deciding whether to establish an Assembly Area.
Protection from environment	Some resources such as cement, foodstuffs, and clothing need to be protected from environmental factors such as rain, wind, or falling debris. Means of protection include storing it in a building, in sealable containers, or in tents.

Storage considerations	Description
Security	Some items need extra protection because they are small, expensive and easy to steal (e.g. electronic items such as GPS devices). Their serial numbers need to be recorded on their resource records. If possible, they should be marked with paint or engraved with the owning agency's name. A lockable secure area may need to be established.
Refrigeration	Refrigeration may be required for foodstuffs when the response provides catering for response personnel and/or food relief to the affected population. Medical supplies are managed by the health sector, but any held by Logistics may need refrigeration. The local DHB will advise on storage requirements.
Hazardous substances 	Hazardous substances have their own storage and use requirements that need to be followed even during a state of emergency, as this helps prevent the situation deteriorating further. Information on hazardous substances is available on Material Safety Data Sheets, and at the Environmental Protection Agency website www.epa.govt.nz . The Ministry of Transport has regulations for the carriage of hazardous substances, particularly around signage on vehicles and driver certification at their website www.transport.govt.nz .
Handling equipment	Forklifts and loaders may be required to move the resource. If so, space will be needed to allow handling equipment to move it off the transport, and to place it in storage. Space for lanes may need to be set aside to allow easy access to these resources. Suitably qualified personnel will be required to operate this equipment.

4.3.3 Issuing resources

Once resources have been received by Logistics, they can be issued to response personnel. The initial record of issue is made in a resource issue register, and then transferred to EMIS or a paper record at the coordination centre. See Appendix E [Resource Issue Register](#) on page 87.

Resources need to be issued to teams so they can carry out their assigned tasks. If insufficient resources are assigned by the coordination centre, Operations is responsible for resolving the issue. However, Logistics personnel may need to exercise their judgement about whether to issue resources that have not been authorised. The decision needs to be based on the nature of the resource(s) being requested, the timeframe for the task, and the relative supply availability of the specific resource(s). For example, a box of disposable earplugs might be issued without authority, while a large generator needed for a week needs to wait for authorisation. These matters may need escalating from the Field Supply team to the coordination centre.

Critical resources must not be issued without written authorisation from the coordination centre's Operations function.

4.3.4 Return or disposal of resources

Once resources are no longer needed, they need to be returned to their owners, or disposed of, and their records need to be closed with comments recording this. See 6.4 [Disposal](#) on page 70 for more information.

4.3.5 Tracking resources

Logistics is responsible for tracking resources, particularly those being stored or used by Logistics. Resources used by other functions and response elements will be recorded by Logistics as assigned to them, and their location and status monitored by the users.

Tools needed to track resources are shown in Table 4-6.

Table 4-6 Tools for tracking resources

Tool	Description
Resource records	These are created in EMIS, T Cards, or by other processes. All resources need to be recorded, including consumables, and resources that have been disposed of.
Receipt records	These record when a resource has arrived and been received by the Supply team. These are critical for establishing and updating an inventory.
Inventory	An inventory is used when carrying out stock checks. EMIS records or T Cards provide the basis for an inventory. EMIS resource records can be placed into a list/spreadsheet and printed out for physical stock checks. Placing resource information into an inventory allows splitting of resource records into smaller units.
Resource Issue Register	Supply uses a resource issue register to record who has been issued with a resource. This is normally a manual log (allowing signatures) which can then be used to update EMIS or T Card records. See Appendix E Resource Issue Register on page 87.

Inventory checks Inventory checks may be needed when resources start to accumulate and the response lasts longer than a few days.

The inventory list is the basis for inventory checks.

The frequency of inventory checks depends on the number of available personnel, the volume of resource, and the size of the Assembly Area. Critical or desirable resources need to be checked daily. Other resources may be checked every 2-4 days or weekly.

SECTION 5 READINESS

This section describes the logistics tasks that need to be carried out **before** an emergency, including:

- gathering current information
- planning and setting up a team and workspaces
- developing processes and supporting documentation, including forms and templates, and
- organising training and development.

Importance of logistics readiness tasks

As shown in Figure 14 below, logistics tasks usually need to occur before Operations tasks are able to be carried out, so being able to establish the Logistics function quickly at the start of a response is essential.

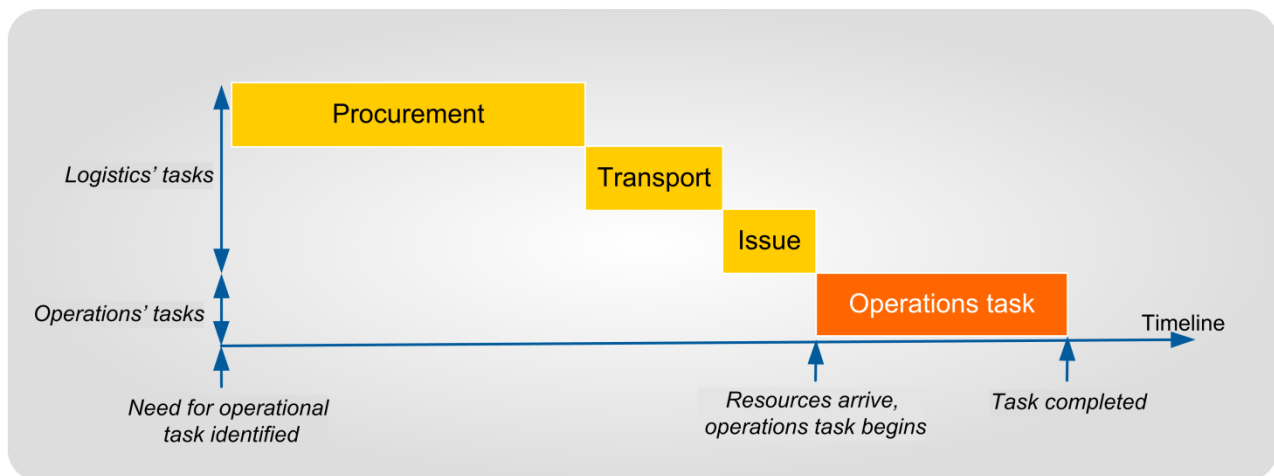

Figure 14 Logistics activities precede Operations' activities

When allocating the time and resources to carry out logistics readiness tasks consider:

- all the preparation done during readiness will be much more difficult, if not impossible, to do at the start of an emergency, and
- if these tasks are not done as part of readiness, the initial response from the Logistics team will adversely affect the overall response's effectiveness, and may limit the capability to save lives or property.

Readiness for the Logistics function



The main task of the Logistics function during readiness is to prepare and maintain its capability so that it is able to procure and manage resources during response and recovery.

Use Appendix F [Logistics readiness checklist](#) on page 92 to ensure that readiness activities are carried out effectively. The Logistics Manager and team need to amend this checklist to reflect the specific tasks required before using the checklist to record their progress in preparing for an emergency.

The Logistics Manager during readiness may be a different person to the Logistics Manager during response and recovery, though this is not ideal.

Developing and maintaining a pool of suitably trained, experienced and engaged Logistics Managers and staff assists in ensuring the seamless activation of Logistics in a response.

5.1 Gathering information

Contact database

The Logistics Manager needs to set up a new database or gain access to an existing database of contact details for everyone they are likely to work with before, during, or following an emergency. This may include:

- CDEM contacts (local, regional, and national), including co-workers, and partners in local authorities
- logistics-related personnel in emergency services and government agencies (e.g. Fire Service, Police, Ambulance, hospital and health services, Defence, and Ministry of Education)
- any other agencies (including lifeline utilities) with a potential logistics role in CDEM (Red Cross, Salvation Army etc.), and
- likely suppliers and vendors.

The contact database must be updated regularly, available both electronically and in hard copy, and be able to be accessed by the Logistics team during and following an emergency.

Local CDEM information

The Logistics team needs to know the local, regional, and national CDEM structure and CDEM personnel relevant to their roles during a response to an emergency.

This includes working out how the Logistics function fits into the CDEM structure, e.g.:

- who the Logistics Manager reports to during and following an emergency (usually different from BAU), and
- what activities the Logistics team are responsible for under the CDEM Group Plan.

Logistics personnel also need access to the following information so they can consider the implications for Logistics during a response, identify the most likely resource needs of their community, and Logistics' ability to support a response:

- Operations' CDEM plans
- analysis of local geography and hazards from a logistics perspective, and
- relevant lifelines utility interdependencies.

5.2 Planning and setting up

This subsection describes the resources that need to be planned for or set up before an emergency, including:

- people
- workspaces, and
- other resources.

5.2.1 Output assessment

Assess, in conjunction with the Controller and other functions, what outputs will be required from the Logistics function. Use the sub-functions as a starting point in this assessment.

It is likely that Finance, Supply, ICT and Administration will be needed, but the other sub-functions may not, or not to as great a degree.

The outputs identified by this assessment will help determine the structure of the Logistics function within the coordination centre.

5.2.2 Risk assessment

When preparing for logistics tasks that will be carried out during a response, it is important to determine any risks, and mitigate them where possible.

Some examples of potential resourcing risks are:

- having one person for the Logistics Manager role, who may be absent, injured in the emergency or otherwise unable to carry out the role
- needing to gain entry to one particular building to access resources for the Logistics team, and the building has collapsed or become inaccessible
- depending on cellphones, but cell towers are overloaded or damaged, and
- not having external/remote access to EMIS to allow updating.

Challenges

Challenges often faced in the Logistics function include:

- needing to organise the Logistics team quickly following activation
- often having to use ad hoc arrangements
- often using untrained personnel, and
- urgency, as Operations and communities need many resources immediately, especially in the early stages of a response.

Ways to mitigate the challenges

Ways to mitigate the challenges include:

- developing clear plans and procedures to reduce reliance on communications
- appointing and training alternate and deputy Logistics Managers
- identifying alternate locations
- pre-event procurement and storage of selected critical resources
- preparing contracts and MOUs
- engaging professional logistics experts
- encouraging key providers to carry out business continuity planning, and
- monitoring and evaluating progress regularly.

5.2.3 The Logistics team

To establish the Logistics team:

- develop the team structure, including required skills
- recruit appropriately qualified and experienced personnel and allocate available staff to team positions
- identify skill, knowledge, and staffing shortfalls
- establish a professional development programme, and
- develop outline rosters so staff know who will respond during an activation.

Develop team structure

Develop the Logistics team structure based on the following:

- the required outputs, as determined in the outputs assessment (confirm these with the Controller)
- outcomes of the risk assessment
- staff (number and skill) and resources available, and
- for each mode of activation, from small to large-scale.

The structure needs to be relevant (designed to produce the required outputs) and realistic (capable of being formed from available resources).

If there is a need for a larger team than can be provided from available staff, particularly for a major emergency, design a team structure suitable to manage it. Shortfalls are then identified, and additional staffing can be requested from higher response levels if required. These will be made available from other CDEM Groups and agencies. Requests for additional staff can be prepared before activation, and sent automatically if required.

When determining possible Logistics team members, the Logistics Manager needs to consider:

- the required structure of the team throughout the anticipated response
- available personnel, and
- training and development requirements (see 5.4 [Training and development](#) on page 61).

Initially, response agencies procure resources from their own supplies and business as usual arrangements. As responses progress, immediately available resources run down and Logistics is needed to procure new resources. Therefore, the number of Logistics sub-functions and personnel may increase during a response.

Table 5-1 Skills required by Logistics sub-functions

Logistics function and qualifications	Required experience	Required knowledge
Manager	<ul style="list-style-type: none"> • CDEM emergencies • Contracts • Financial delegation • Team management 	<ul style="list-style-type: none"> • Logistics (including this guideline) • <i>Resource Classification Guide</i> • BAU procurement system • BAU finance system • EMIS, particularly 'Logistics' & 'Tasks' pages
Finance	<ul style="list-style-type: none"> • Finance office 	<ul style="list-style-type: none"> • BAU finance system • EMIS 'Finance' page
Supply		<ul style="list-style-type: none"> • BAU procurement system • EMIS ('Supply and Transport' and 'Finance' pages) • <i>Resource Classification Guide</i>
ICT	<ul style="list-style-type: none"> • ICT planning • ICT device training (for operators) 	<ul style="list-style-type: none"> • Coordination centre communications systems (phone, internet, radio etc) • <i>Resource Classification Guide</i>
Administration	<ul style="list-style-type: none"> • Administration 	<ul style="list-style-type: none"> • BAU administrative systems and document management
Personnel	<ul style="list-style-type: none"> • Recruitment • Induction • Training support 	<ul style="list-style-type: none"> • Volunteer registration system • CDEM training • Response structure, including volunteers
Transport	<ul style="list-style-type: none"> • Transport (driving and/or task planning) 	
Catering	<ul style="list-style-type: none"> • Contracts • Food service administration 	
Facilities	<ul style="list-style-type: none"> • Contracts • Property management 	<ul style="list-style-type: none"> • BAU property management system

Required skills

The skills required for Logistics sub-functions are listed in Table 5-1 on the previous page. The team leaders of each sub-function need to have all of the listed skills, but other members of the team may have only one or more of the skills, depending on the tasks they will be assigned.

Ideally staff in all of these functions will have received CIMS training so that they can understand the wider response structure, roles, and responsibilities.

Identifying possible people

Once the required skills are determined, a pool of people can be established.

At a minimum, identify personnel to assign to the following appointments:

- Logistics Manager
- one or more alternate deputy Logistics Managers (may be one or more sub-function Team Leaders)
- Supply Team Leader(s)
- ICT Team Leader(s)
- Finance Team Leader(s)
- Administration Team Leader(s), and
- any other appointment where the function will definitely be activated (e.g. a Facilities Team Leader, if the coordination centre is activated in a different location).

Start by identifying personnel within the CDEM organisation (including CDEM-trained volunteers). Align a person's BAU roles as closely as possible with their response roles, to make the best use of their skills, knowledge, and experience.

Shortfalls and additional Logistics staff

Next, ensure that any skill gaps are identified, and arrange to 'borrow' people from other local organisations, and train them. Staff with skills in procurement, supply, or other logistics skills may be accessed from:

- other agencies
- personnel from other local authorities, and
- commercial logistics companies.

Considerations for using commercial companies include:

- that they may provide immediate access to facilities, equipment, and connections to similar companies
- the need to be impartial when working with all local business, and
- setting up arrangements (contracts or MOUs) before an emergency.

It is important to make sure that any borrowed personnel will not be needed in their BAU role during an emergency, and that the Logistics Manager has a clear understanding of the additional staff's priorities and availability.

Rosters

The Logistics Manager needs to prepare draft rosters of Logistics personnel and manage and adapt rosters to meet the needs and realities of each particular response. It is important to make sure that the pool of Logistics team members is sufficient to allow for two or three shifts a day, especially for the first 2-4 days of a response.

Personal preparedness



All members of the Logistics team need to be prepared for an emergency at home as well as at work, including having emergency provisions and an emergency plan. Having this in place before an emergency will help the Logistics team to carry out their roles effectively during an emergency.

Information on how to be prepared at home for an emergency is available at the Get Ready Get Thru website, at www.getthru.govt.nz.

5.2.4 Logistics workspaces

When planning where the Logistics team will set up during an emergency, consider:

- proximity to CIMS functions that work closely with Logistics such as Operations, Planning, and the Controller
- resource availability, such as phones, power supplies, computers, and ICT support
- space to expand if the Logistics team increases
- security and access (keys, swipe cards, and ID cards for any cordons), especially for out-of-business hours, non-local authority personnel, and when the main key holder is not present, and
- alternative venues in case the main venue is unavailable.

Logistics requirements at a coordination centre

Logistics at a coordination centre will require the following:

- workstations for all personnel (desks, chairs, and landline phones with reliable connections)
- sufficient computers to allow resource tracking, procurement action and email communication with resource providers
- access to EMIS
- access to any required BAU financial and procurement systems
- access to printers, copiers, and scanners
- dedicated email accounts and phone lines
- access to coordination centre reference manuals, plans, procedures, and documentation, and
- maps, projectors, screens, whiteboards and/or display boards for displaying information.

Logistics requirements at an Assembly Area

Logistics at an Assembly Area will require the same as a coordination centre, possibly with the additional resources:

- buildings, portable cabins, or tents
- access to ablutions (toilets, showers, hand basins)
- accommodation for Assembly Area personnel, and
- access to catering spaces and equipment, including places to eat and to wash dishes.

5.2.5 Other Logistics resources

This subsection refers to any resources that the Logistics team may need, other than people and workspaces (covered in the two previous subsections).

The Logistics Manager is responsible for determining the equipment and supplies the Logistics team is likely to need in an emergency and ensuring that these are available and in good working order.

Personnel identifiers

Logistics personnel will need identifiers, such as vests or name tags. These should be in the Logistics function colour of yellow, with 'Logistics' clearly written on them in black. Sub-functions and appointments should also be noted.

Phones

Consider attaching landline and cellphone numbers to roles, rather than to individuals. This ensures that:

- the number is current for the duration of the emergency
- contact information can be circulated as soon as an emergency occurs (no need to confirm who is doing what first)
- contact information does not change every shift, and
- off-duty personnel are not contacted in error.

Logistics response resource boxes

Consider storing Logistics response resources in labelled boxes, so they are:

- easily identifiable
- accessed as one item
- lockable, and
- easy to relocate if necessary.

If Logistics response resource boxes are used, ideally there should be boxes with identical content stored in at least two different locations.

Logistics response resources need to be stored:

- in spaces unlikely to be affected during an emergency, and
- where they are accessible to any person on the roster for the initial Logistics team.

Hard copies of information

Keep current hard copies of any information that may be needed during and following an emergency (for example, the contact database).

Hard copies must always be available, in case electronic copies are not accessible during power or telecommunications outages. The Logistics Manager may decide to keep an up-to-date hard copy of the outline contact list with them at all times.

Electronic copies of information

Store electronic versions of the Logistics CDEM information in the EMIS portal, USB flash drives, and/or smartphones, so that the information is always available wherever the Logistics staff are and is easily transportable.

Processes to update these versions regularly need to be developed and followed. Note that hard copies need to be available as well, in case of power or telecommunications outages.

Response resources

Consider holding stocks of equipment and supplies that will be needed in the initial stages of a response, particularly in any area that is likely to be cut off. Resources that may be effective to hold include:

- Welfare items such as blankets, bedding, cots, sanitation equipment (portable toilets), lighting
- ICT equipment such as laptops, radios, and satellite phones
- construction materials such as sandbags, tarpaulins, shovels, chainsaws, and
- any critical resources identified during readiness planning.

When deciding which stocks to hold, and how much, balance the costs involved in procuring, storing, and maintaining resources against the potential usefulness of the resources during a response. Also consider the anticipated demand and how long it will take to procure the resource during a response.

5.3 Developing processes and supporting documentation

Some Logistics personnel will be inexperienced and may have had little or no training before a response, so when developing Logistics procedures:

- describe the tasks, and the responsibilities of the different roles in sufficient detail, using Plain English, avoiding jargon and acronyms so that it is easier for personnel (often under stress) to understand and follow, and
- use tables, diagrams, and lists wherever possible.

Preparation

Before writing the procedures, confirm the structure of the coordination centre, the roles and responsibilities of each of the functions, and their relationships to one another.

Once the broader coordination centre structure and responsibilities have been determined, carry out a basic analysis of the area of responsibility, the hazards, likely emergencies, demographics, and local businesses from a logistics viewpoint. The aim is to gain an understanding of:

- what type of emergencies are possible (such as flood, tsunami, volcanic eruption)
- the potential scale of response (such as the range of response agencies, numbers of personnel, types of equipment needed), and
- the functions that Logistics will need to provide (e.g. will catering or accommodation be provided for response personnel by the coordination centre).

This should be conducted jointly with Intelligence. See 2.3 [Logistics structure](#) on page 14 for more information on the structure of coordination centre Logistics.

5.3.1 Planning



There are two types of plans discussed in this guideline:

- *Logistics CDEM Plan* is prepared during readiness (see Appendix C [Developing a Logistics CDEM Plan](#) on page 79)
- *Logistics Appendix for the Action Plan* is developed during a response (see Appendix I [Logistics Appendix for the Action Plan-template](#) on page 100).

Logistics CDEM Plan

The Logistics Manager should prepare a *Logistics CDEM Plan*, or Logistics section of the Group or Local CDEM Plan. *Logistics CDEM Plans* include all the planning for CDEM Logistics; the roles, responsibilities, and processes necessary for the Logistics function in readiness and response. This is developed by working through Section 5 [Readiness](#) of this guideline.

See Appendix C [Developing a Logistics CDEM Plan](#) on page 79 for a summary on the recommended content.

5.3.2 Role descriptions

Logistics role descriptions need to include:

- role title
- position in the response structure and reporting lines
- required competencies
- role responsibilities
- any financial delegations, and
- any available procedures for their tasks (in full, or where to access them).

The task procedures need to be:

- in Plain English – avoiding jargon and acronyms
- clear and concise, and
- broken into sequential steps where practicable.

5.3.3 Assessing likely resource needs

Using the information already gathered on likely hazards and risks within the area, to determine resources that are likely to be used, become critical, or will be a high priority. Use this information as the basis for approaching possible sources and setting up contracts, MOUs, or agreements.

5.3.4 Assessing critical resources

Determine any resources likely to be critical or high priority, based on the various hazards in the area and known resource criticalities. Then develop:

- lists of potential local providers of critical resources, and
- draft Resource Requests, ready to be sent if a particular hazard eventuates.

Only track resources that are likely to be critical or high priority, as the lists will need significant staff time to keep current.

Critical resources are described in section 4.3 [Critical resources](#) on page 40.

5.3.5 Setting up contracts or MOUs

If there are businesses or agencies that are likely to provide critical resources, or to provide resources on a regular basis in a response, consider formalising these arrangements with contracts or Memoranda of Understanding (MOUs). This will likely be done by EM Officers, Controllers or by the BAU organisation.

Contracts

Contracts are legally enforceable agreements. They state the parties to the agreement and what each party is to provide (usually goods and/or services in exchange for money).

Contracts need to be used when a local authority wants to ensure that the contracted resource (either a good or a service) is provided. This provides a higher degree of certainty, but is likely to cost more. MOUs (see below) are likely to be cheaper, as they provide some flexibility to the resource provider, but this may mean that the agreed resource is not provided when it is required.

MOU

MOUs are documents that set out the intentions of the parties, but are not intended to be legally enforceable. If one or more party does not follow through on its promise, the other party has no ability to compel performance or seek damages.

If an MOU sets out terms in the nature of a contract, and the parties act accordingly, a Court may determine that the document is actually an enforceable contract. Staff need to be careful when preparing and using MOUs to ensure they do not become binding contracts.

5.3.6 Purchasing and payments

How purchasing and payments will be made in a response needs to be documented in the readiness phase. See 4.2.4 [Purchasing](#) on page 40 for additional information.

Government assistance

Government assistance may be available during an emergency; see Appendix D [Government financial assistance](#) on page 82 for a full explanation. Staff with appropriate authority need to understand these processes so they can ensure that any financial processes developed for use during response and recovery will meet the criteria, and support claims.

Considerations for delegations

When setting up preapproved financial delegations consider if it needs to be:

- contingent on the:
 - declaration of a state of emergency
 - approval of the Controller
- given to non-council personnel who might be appointed to roles with financial delegations (such as supplementary personnel from other local authorities, partner organisations, or community volunteers).

Section 94 of the *CDEM Act 2002* contains provisions for specific members of a CDEM Group to enter into any contract on behalf of that CDEM Group. Three of these are the chairperson and the deputy chairperson of the CDEM Group, and the Group Controller. In addition, section 94 (1) (c) allows any CDEM Group employee authorised in the Group Plan to enter into any contract on behalf of the CDEM Group.

The Logistics Manager needs to ensure that CDEM Group/local authority documentation, including, where necessary, the delegation register:

- lists any employees who may need to enter into a contract on behalf of the CDEM Group/local authority are identified and authorised, and
- provides for any required personnel from outside the local authority accessing funds or authorising spending during a response.

5.3.7 Review operational plans

Operational plans and arrangements should be reviewed from a logistics perspective, in order to anticipate what resources might be required, how quickly they will be needed, and what Logistics sub-functions will be required to support the response. This activity can be used as the basis for a training exercise, where staff can use the plan or arrangements to brainstorm the logistics needs. These findings should be documented, preferably in a Logistics plan to support that response, or in the Logistics SOPs.

5.3.8 Archiving

Local government must archive records under the *Public Records Act 2005*.

Logistics Manager responsibilities include ensuring that all Logistics records are archived following the record management processes in their CDEM and/or local authority office.

The Logistics team may need to develop processes for storing information (hard and/or soft copies) that is handled by the Logistics team during and following an emergency. This will ensure that the information can be easily retrieved for archiving when there are resources and time available to do so.

Advice on archiving, including which records need to be kept, and the requirements of how they are archived, is available from Archives New Zealand, by searching 'Advice on archiving' on their website

www.archives.govt.nz.



5.4 Training and development

During readiness the Logistics Manager is responsible for ensuring that a development needs analysis is carried out for staff and volunteers who carry out logistics tasks during readiness, or who are intended to carry out logistics tasks during response and recovery.

Logistics personnel need to have training to ensure that they know their roles, their assigned responsibilities, and how they are to fulfil these during a response. This is based on the logistics procedures. Training may include:

- lectures, hands-on training, and workshops
- shadowing and mentoring
- attending CDEM and related exercises (see paragraph below)
- attending conferences and other professional development opportunities
- participating in responses led by other organisations, and
- team table-top and functional exercises.

Training material

Training material needs to be:

- based on logistics procedures
- available at all times, and
- role specific so new personnel aren't overwhelmed with information they don't need.

Training development topics

Training and development may cover logistics during response and recovery in general, or cover specific topics such as:

- setting up interagency logistics teams and communications
- processing Resource Requests
- financial procedures during response and recovery
- procuring resources
- setting up ECCs/EOCs and/or Assembly Areas, and
- sub-function specific activities.

Attending CDEM exercises

Personnel who may be involved in logistics tasks may have opportunities to participate in exercises run locally, regionally, or nationally.

As well as preparing people for their roles, CDEM exercises also provide an opportunity to test procedures.

Information on local and national exercises is available from the EM Officer or GEMO Manager. Information about national level training and development in logistics is also available from MCDEM.

Responses in other local authorities

Staff may deploy to other local authorities, CDEM Groups or NCMC during a response, to increase capacity and capability for the affected authority. This will allow the deployed staff to gain valuable experience managing a response. It also allows staff to develop relationships with their peers in different authorities, which may be invaluable in subsequent responses.

Shadowing and mentoring

Shadowing someone while they carry out logistics tasks provides opportunities to learn skills from someone with expertise. It also provides an opportunity to carry out peer review. It may be particularly useful during response and recovery.

Mentoring is an effective way to provide guidance to personnel who are new to the role. It can be done remotely if there is no-one in the same agency with the required skills. This depends of the availability of mentors.

Regional workshops

Some GEMOs and partner agencies run workshops for Logistics personnel. They may invite Logistics personnel from other organisations that they will work with during an emergency.

The workshops may be a general sharing of processes, information and ideas, or cover specific topics.

Other logistics training

Attending training courses run by other organisations on logistics, or specific aspects of logistics, is another way to increase skills and establish relationships with other staff.

SECTION 6 RESPONSE AND RECOVERY

This section describes the logistics tasks that need to be carried out in response and recovery.

6.1 Starting up

Follow the plan and checklist

The Logistics team follows the procedures developed during readiness, and may use a checklist (see a suggested format in Appendix H [Logistics response checklist](#) on page 97) to keep a record of which steps are done.

Personnel considerations

Personnel need to be given sufficient time when they begin in a role to familiarise themselves with the content of the response procedures.

Availability of qualified personnel may be an issue. In this case, coordination centres should not hesitate to issue a Resource Request to their respective ECC or the NCMC, asking for additional staff. These can be sourced from around New Zealand and across government agencies to expand capacity in understaffed coordination centres.

Naming conventions

The following naming convention for filenames is designed so that when files are stored electronically in a folder they sort into a logical sequence that is easy to search through, especially during an emergency when many documents, situation reports in particular, are likely to be shared between agencies and between different levels of the response.

The naming convention for filenames is:

- organisation initials, and the place the report is coming from
- type of report; '#' and sequential reference number, including zeros as place holders, and
- date in the format yyyy-mm-dd, including zeros as place holders.

Some examples are:

- Wainui DC EOC SitRep #04 2013-04-31
- NZFS ECC AP #01 2012-09-31
- NCMC SitRep #17 2014-02-29
- USAR Blue River ICP SitRep #09 2017-11-31

The footers of all files need to include:

- the filename (by inserting the filename field), and
- pagination – for example 'page x of xx'.

Government assistance

Some government assistance may be available at the beginning of an emergency. Determine whether to apply for an advance payment near the beginning of any significant emergencies (See Appendix D [Government financial assistance](#) on page 82 for a full explanation).

6.2 Response actions

6.2.1 Logistics contribution to the Action Plan

Action Plans

During an emergency the coordination centre, support agencies and subordinate response elements will be operating under the coordination centre's *Initial Response Plan* or *Action Plan*.

An *Initial Response Plan* is developed before or in the early stages of a response. It is designed to coordinate the immediate actions of responders, as well as gather information and mobilise resources. It does not normally aim to set the conditions for a transition to recovery.

The *Action Plan* is prepared as soon as there is enough information to describe the intended actions for the response with some degree of certainty. In small emergencies, this may be within a few hours of the onset of the emergency, but in large emergencies this may take several days.

An *Action Plan* should remain valid until its objectives are met, and may be updated to reflect minor changes in the situation. A new *Action Plan* is only developed if the original *Action Plan* becomes unviable because of major changes in the situation or there are other response objectives to be completed. This is described in the *Response Planning Director's Guideline*, available at www.civildefence.govt.nz by searching the document name.



The Logistics function must be involved in all stages of the planning process. The key input of the Logistics function into the *Action Plan* process is to ensure that the plan is logistically supportable with the current and expected levels of resources. In turn, involvement in the planning process gives Logistics staff advance warning of key logistics activities that will be required.

Logistics Appendix

The *Logistics Appendix for the Action Plan* describes the intended actions of the Logistics team. It is most useful for more complex responses, where the Logistics content for the main body of the *Action Plan* may be too lengthy.

A *Logistics Appendix* is developed as part of the response planning process. After a planning option has been selected by the Controller, the Logistics representative on the planning team will document the logistics arrangements that have been decided as part of the planning process. This forms the basis of the *Logistics Appendix*.

It details the logistics arrangements needed to support the *Action Plan*, without cluttering the main document with text that only Logistics staff will need. In many cases an *Appendix* will not be required, as the response may be small enough that logistics arrangements can be described adequately in the main body of the *Action Plan*.

The Logistics Manager is responsible for:

- contributing to the development of the *Action Plan* including writing any Logistics-specific content, working with the Controller, Planning, Intelligence, and Operations Managers, and
- developing the *Logistics Appendix for the Action Plan* if this is required.

When planning the Logistics response, make sure the activities will be:

- based on supporting the Controller’s intent, as described in the *Action Plan*
- simple, efficient, and flexible
- coordinated with other functions, including Logistics sub-functions through effective communication, and
- designed to anticipate future needs.

The *Logistics Appendix for the Action Plan* is approved by the Controller.



There is a [Logistics Appendix for the Action Plan-template](#) in Appendix I on page 100, and also a [Logistics Appendix for the Action Plan-example](#) in Appendix J on page 102.

The recommended headings for the *Logistics Appendix of an Action Plan* are given in Table 6-1 below.

Table 6-1 Headings for a Logistics Appendix for the Action Plan

Heading	Content of section
Hazard and situation	A summary of the hazard and situation reports, from a logistics perspective. Do not simply repeat the information in the <i>Situation Report</i> or <i>Action Plan</i> . Only include information relevant to logistics.
Higher response level logistics plan	If a higher response level is activated, summarise their logistics plan, and any key facilities they may have established to support the Group/local response.
Overview of Logistics response	A brief description of how the Logistics function will operate during the response. This must be aligned with the <i>Action Plan</i> .
Sub-Function arrangements	For each sub-function activated within the response, describe how that sub-function will operate, including links with other agencies.
Coordinating instructions	Include timing requirements (deadlines, briefings etc), roster, and locations for the Logistics teams.
Logistics control arrangements	The Logistics team roles and structure, where to find the description of the Logistics team roles, contact information, who is assigned to those roles, and scheduled meeting times.
Attachments	Maps, tables, and other items that are needed for the appendix, but too long to include in the main body of the appendix.

6.2.2 Transportation priority list

A transportation priority list will assist in ensuring that essential loads are moved first. It is only necessary when there is a shortage of transport capacity.

Logistics is responsible for informing Operations if traffic controls are needed and if there are any priorities for logistics. The priority lists are developed and maintained by Operations.

An example from the 2010 *Wellington Earthquake National Initial Response Plan* is given in Table 6-2 below.

Table 6-2 Example of a transportation priority list

Inward priorities (most important first)	Outward priorities (most important first)
1. Medical supplies, equipment and personnel	1. Casualties with immediately life-threatening injuries (Status 1)
2. Urban Search and Rescue	2. Personnel critical to the functioning of government and management of the response
3. CDEM personnel (to coordinate the regional and local response)	3. Casualties with potentially life threatening injuries (Status 2)
4. Welfare supplies (water, food, shelter)	4. Couriers with response-specific information
5. Firefighting supplies, equipment and personnel	5. All other requests (including tourists and other non-residents)
6. All other requests	

Using this list, if there is an aircraft flying into Wellington, and it can carry either medical supplies (priority 1) or CDEM personnel (priority 3), it would take the medical supplies.

If firefighters (priority 5) and a news crew (no priority) wanted to use the same aircraft, it would be allocated to the firefighters.

Transport plan

Transport develops and maintains a Transport plan when required, which is part of the *Logistics Appendix to the Action Plan*. It is usually developed when transport routes or key infrastructure are damaged or compromised to the extent that standard transport arrangements are insufficient to meet community and response needs.

Transport plans are developed in conjunction with other Logistics sub-functions, Operations, lifeline utilities, Liaison Officers, and Welfare, with advice from the Planning team. Personnel from the NZ Transport Agency, local roading authorities, ports, and rail will be required to help develop these plans. Transport plans need to include:

- identification of key and alternative routes and means of transport
- estimated time for reinstatement of damaged or compromised routes
- allocation of transport resources to tasks and/or response entities
- movement priorities along routes (including air movement), and
- movement control (Police-led).

6.3 Ongoing tasks

The tasks in this section are completed throughout response and recovery.

6.3.1 Identifying critical resources

Critical resources are those that are not available in sufficient quantity to meet all demands, and which have a direct, material impact on a response. Critical resources are confirmed by the Controller, often on advice from Operations and Logistics. Critical resources may be held by Logistics or their owners, but are only released to tasks with the approval of Operations.

Critical resources often vary between NCMC, ECCs, and EOCs. Therefore each Controller is responsible for determining their critical resources and the criteria for issuing them.

Resources that are critical for some response elements but readily available to others are redistributed by coordinating across boundaries and through the use of Resource Requests.



Resources can be identified as being critical in EMIS (instructions are in the *Messaging, Tasks, and Resources User Guide*). This ensures their status is considered when the resources are allocated.

Written approval from Operations (email, meeting minutes, an Operations log, and/or the EMIS resource record) is required before critical resources are issued. Logistics (particularly Supply) also needs to be informed, so they can ensure the resource is only issued with Operations' written authority.

6.3.2 Purchasing and payments

Purchasing during or following an emergency requires Logistics personnel to balance urgency against the need to be accountable.

For example, Logistics may need to contact businesses directly, rather than go through a tendering or price comparison process in the immediate response phase (see Appendix N [Procurement phases during an emergency](#) on page 111 for more information on the phases).

When purchasing resources during response or recovery, always consider:

- Whichever procurement process is used, it is still subject to audit. Documents must be filed in accordance with the *Public Records Act 2005*.
- Record Phase 1 (Immediate response) procurements as soon as practicable, clearly stating that the purchase was an emergency procurement and the facts/circumstances justifying this approach.
- When the emergency moves from Phase 1 (Immediate response) to Phase 2 (Disaster relief), re-establish normal procurement practices to ensure safeguards and accurate record-keeping are in place.

- There is a higher risk of fraud and inflated prices during a response. This is due to the relaxing of safeguards built into normal procurement and payment practices.
- There may be possible conflicts of interest, which must be managed appropriately. This risk is elevated if industry personnel are on the Logistics team.

Checking invoices Invoices must be checked against goods and services received, usually by Field Logistics staff, ICP Logistics, or personnel receiving the resources and reporting back. Coordination centre Supply checks the invoice against any quoted or contracted figure, and queries any discrepancies.

If the invoice matches the resources received and is at the agreed price, the invoice can then be authorised by the appropriate person, and paid by Finance (the order for these two steps depends on the process of the coordination centre). Supply and Finance also need to track the invoice through this process, to ensure it is not lost or delayed unnecessarily.

6.3.3 Requisition

If a state of emergency has been declared, consider whether any resources need to be requisitioned, as this power is now available – or if requisitioning would materially assist the response whether a declaration should be recommended on those grounds. See 4.2.5 [Requisitioning](#) on page 42 for more detail.

6.3.4 Receiving goods

When resources are received from external providers directly by other functions at the coordination centre, or by response personnel, Logistics needs to be informed. Logistics personnel may be dispatched to oversee receipt and tracking of resources.

6.3.5 Transport

Fuel Pre-existing facilities such as service stations, truck-stops, transport and civil engineering bases, and agricultural enterprises are best used to source fuel, unless the infrastructure is badly damaged.

Improvised fuel points are only established if pre-existing facilities are not available. Improvised fuel points may use tankers, bladders, or drums of fuel along with pumps and operators. However, these may require time to establish, and have a higher risk of accident than pre-existing facilities, unless operated by experienced and qualified refuelling specialists.

Certification

Ensure operators that are sourced separately from the vehicles have appropriate certification.

Traffic control

Control of traffic routes and nodes by the coordination centre only needs to be carried out when:

- it is necessary to ensure that response transport is not blocked by non-essential traffic, or
- safe and expeditious movement of the public or commercial transport is unnecessarily hindered.

When traffic routes or nodes are controlled, Operations needs to ensure that Public Information Management is informed so that they can inform the public, and that the other response agencies are advised.

If traffic control is established on a road, it will require Police or roading contractors to place road-blocks and/or checkpoints at both ends of the restricted road to control access. Where possible, alternate and detour routes should be established and signposted for non-essential traffic. If not, holding areas and turnaround points will need to be placed at the checkpoints.

Any traffic seeking to use this route must apply to Operations in the coordination centre that controls access along this route.

Traffic control through an airport or port will be handled by the airport or port company that schedules flights or sailings. In these cases it may be advisable to have a liaison officer from the airport/port in the coordination centre to coordinate flights and sailings. NCMC may be involved, as inbound flights and ships may have been organised at the national level.

Operations set the load priorities for flights and sailings. Logistics sets the detailed load list in accordance with those priorities.

6.3.6 Monitoring and evaluation

During response and recovery, the Logistics Manager is responsible for monitoring and evaluating the Logistics function's activities, and those of any activated sub-functions. This may include:

- regular meetings with other function managers, and Logistics sub-function team leaders
- communicating with Logistics Managers in other coordination centres, to ensure resource requests are proceeding as needed
- checking with responders to ensure they are receiving the required resources in the correct quantities, at the right place and time
- checking priority changes and changes in stock-holdings
- reviewing records to see how long resources are taking to get to requesters, and
- reviewing correspondence (such as Offers of Assistance, directions from the Controller, communications with suppliers) to determine how long it is taking to give responses and take any consequent actions.

6.4 Winding down

As the recovery from the emergency progresses, the Logistics team's tasks will progressively be returned to business as usual (BAU) arrangements and providers.

6.4.1 Managing resources

Handover stocktake

Once response and recovery activities are winding down, the Logistics Manager needs to ensure that a stocktake is carried out, which includes identifying whether resources are:

- needing maintenance
- kept for BAU use
- returned to supplier
- donated, or
- disposed of.

Returning resources to a higher level coordination centre

Resources that were obtained from higher level CDEM coordination centres need to have return transport arranged. Once their return has been confirmed, the resource record (whether in EMIS or manually) needs to have the controlling agency updated.

This removes the record from the coordination centre's list of resources. Other ECCs/EOCs may then seek to procure the resource.

Return of loaned/hired resources

Resources that have been borrowed from an agency, NGO, or commercial provider, requisitioned, or been hired, can be returned by informing the owner. Contracts may be left to expire, or an earlier end-date negotiated. Return arrangements are made with the owner, if these were not made during procurement. Cleaning, maintenance, and transport may need to be arranged first, depending on the agreed arrangements.

Retain T cards

'T Cards' for returned or disposed resources need to be placed in a separate file. Never delete or destroy resource records, as they may be needed again; either during the response, or for post-response debriefing and analysis.

Disposal

When resources have been purchased by the coordination centre and are no longer needed for the response, or for BAU, they are disposed of. The decision for disposal must be clearly recorded.

Ways of disposing of resources include:

- donation – considered for resources that are usable but with limited resale value, or that are widely dispersed and difficult to collect. They can be donated to other response or recovery organisations, other local authorities, or the public
- selling – must be done on the open market to maximise the price, preferably through a reputable auctioneer. Use any existing BAU procedures for selling unwanted resources, and
- dumping – only applies to resources that cannot be donated or sold. Waste management regulations and procedures apply.

6.4.2 Applying for Government assistance

Government financial assistance may be available once response and recovery are completed, and the costs are finalised. (See Appendix D [Government financial assistance](#) on page 82 for a full explanation).

6.4.3 Debriefing the Logistics team

The Logistics Manager is responsible for debriefing the Logistics team as they are stood down or finish their response, including reviewing:

- how they did against their objectives and assigned tasks
- whether rosters and team management worked effectively
- what was learned, and
- any effects on personnel, including psychosocial issues.

The Logistics Manager will also contribute to the wider debrief within the Incident Management Team, which will provide external feedback on the performance of the Logistics function. These debrief points are used to update procedures, to ensure that lessons are not forgotten.



The MCDEM publication *Organisational debriefing* is available on the MCDEM website www.civildefence.govt.nz by searching for the document name.

6.4.4 Reviewing procedures and documentation

Following response and recovery, the Logistics Manager is responsible for ensuring a review of procedures and documentation is carried out, any areas for improvement are identified, and the procedures and documentation amended. The review is based on the debrief of all Logistics personnel, and should include feedback from external parties who provided or received any resources.

It is essential that experience gained in a response is preserved, by amending and updating procedures and training.

SECTION 7 APPENDICES

APPENDIX A Centre and Field Logistics	73
APPENDIX B Assembly Areas and Staging Areas.....	74
B.1 Staging Areas	75
B.2 Assembly Area.....	76
APPENDIX C Developing a Logistics CDEM Plan	79
C.1 Content.....	79
APPENDIX D Government financial assistance.....	82
D.1 Financial assistance after an emergency	82
D.2 Claim form	86
APPENDIX E Content for forms.....	87
E.1 Resource Issue Register.....	87
E.2 Transport Tasking	88
E.3 Offers of Assistance	89
E.4 Resource Request	90
APPENDIX F Logistics readiness checklist.....	92
APPENDIX G Logistics response procedure.....	94
G.1 Logistics response activation	94
G.2 Setting up Logistics team and workspace	94
G.3 On-going logistics tasks.....	96
G.4 Winding down	96
APPENDIX H Logistics response checklist	97
APPENDIX I Logistics Appendix for the Action Plan-template.....	100
APPENDIX J Logistics Appendix for the Action Plan-example.....	102
APPENDIX K Resource Request procedures	105
K.1 Procedure for submitting a Resource Request.....	105
K.2 Procedure for processing received Resource Requests.....	106
APPENDIX L Task log	108
APPENDIX M Task sheet	110
APPENDIX N Procurement phases during an emergency	111
N.1 Phase 1 – Immediate response (reactive procurement)	111
N.2 Phase 2 – Disaster relief (emergency procurement)	112
N.3 Phase 3 – Post-disaster recovery (accelerated procurement)	113
APPENDIX O Transport background information.....	114
APPENDIX P Glossary	116

APPENDIX A Centre and Field Logistics

In larger responses, Logistics may be divided into Centre and Field Logistics as shown in Figure A-1 below.

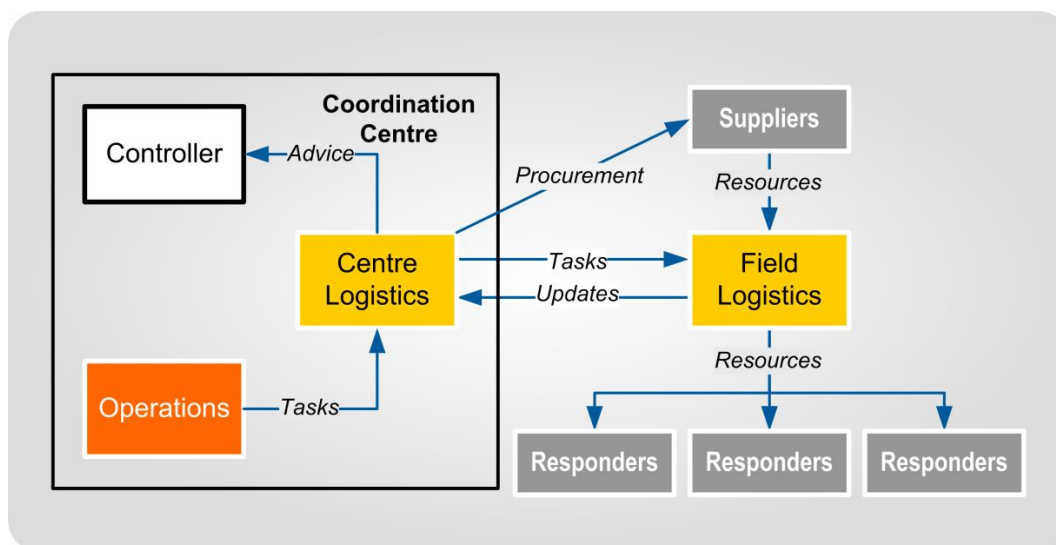

Figure A-1 Centre and field logistics

Centre Logistics

Centre Logistics is conducted by the Logistics team in the NCMC, ECCs, EOCs, and ICPs. Its responsibilities include:

- the planning of logistics support (with the other CIMS functions)
- the provision of logistics advice to the Controller and other function managers
- the provision of Logistics function input into Action Planning
- resource tracking
- procurement, and
- issuing logistics tasks, primarily to Field Logistics personnel.

Field Logistics

Field Logistics is the physical provision of logistics support to the responding agencies (including Civil Defence Centres). Field Logistics teams are tasked by Centre Logistics. If Operations wants to task Field Logistics staff, they assign the task to the Logistics Manager in the coordination centre.

Field Logistics' responsibilities include:

- receiving, storing, and issuing resources
- transport of resources and responding agency equipment
- providing administrative, catering, and accommodation support to response personnel
- maintenance of response equipment and supplies, and
- advising Centre Logistics of resource levels, response personnel's needs, and operational conditions.

Effective communications are essential between Centre and Field Logistics teams that are operating in separate locations.

APPENDIX B Assembly Areas and Staging Areas

Purpose

During a response, the volume of resources required may exceed the capacity of an ECC or EOC to store and manage them.

This can be managed by setting up:

- Assembly Areas - established by NCMC, ECCs and EOCs when significant amounts of resources are being managed, usually sited away from incident sites, and
- Staging Areas – established at incident sites.

The relationship between an Assembly Area and Staging Areas is shown in Figure B-1 below.

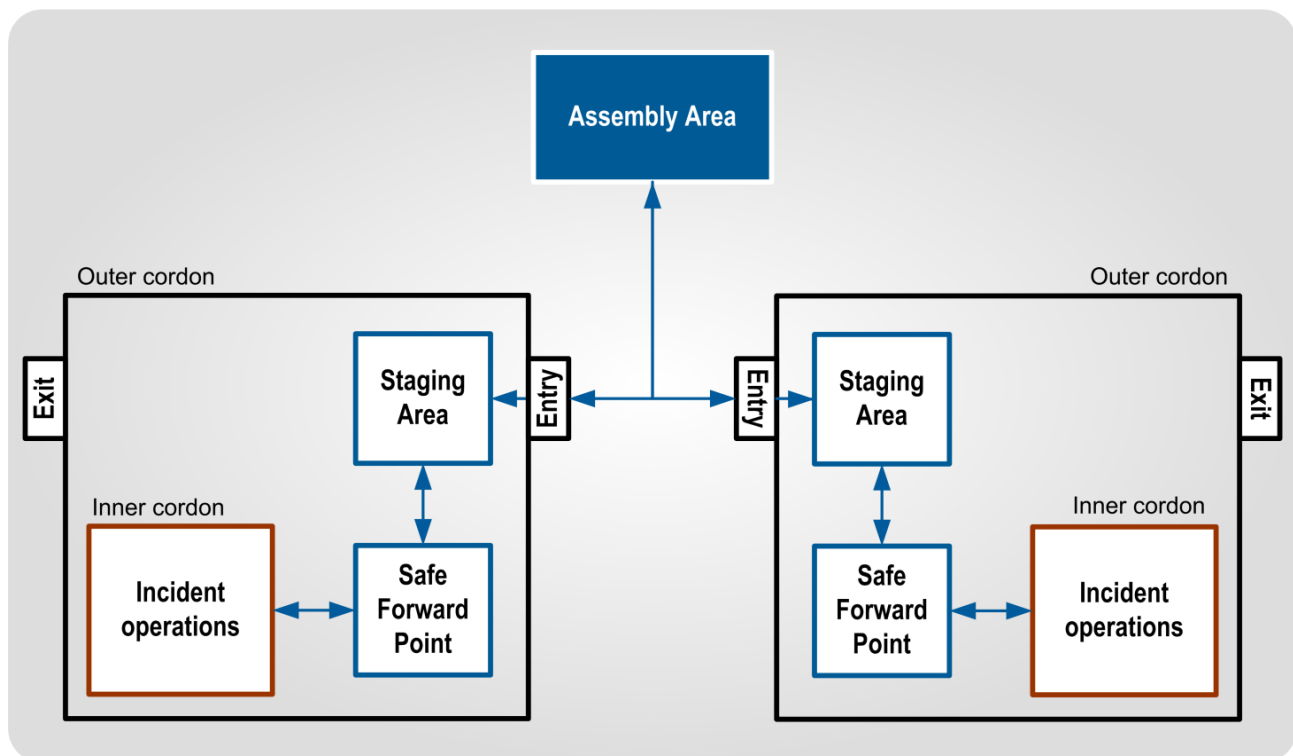

Figure B-1 Relationship between Assembly Area and Staging Areas

B.1 Staging Areas

Staging Areas are locations at incident sites where resources are gathered and organised before being dispatched to the incident operations area (directly or via a Safe Forward Point). A Staging Area provides a safe location for:

- resources to be received and held by an Incident Controller prior to deployment
- resources to prepare for assigned tasks (equipment checks, planning, briefings, and loading), and
- response personnel to recover after returning from a task (cleaning, repairs, rest, meals, reorganisation, and resupply).

Staging Areas are managed by Operations, who work with Logistics when resource management is required. A Staging Area needs to be distinct from other response facilities, even when they are in the same location, to ensure proper control and supervision of these resources and personnel.

Considerations when establishing Staging Areas

When establishing a Staging Area consider:

- its proximity to the location where assignments are made
- the safety of the location
- the occupational health and safety of response staff who will be using the Staging Area
- having separate entrances and exits
- placing it off main traffic routes, but where it is easy to locate them
- ensuring it can accommodate anticipated levels of resources
- whether separate locations are required for different types of resources, and
- any potential environmental damage by vehicles or personnel.

Advantages in using Staging Areas

Staging Areas advantages include:

- more effective accountability
- allows team leaders to organise and brief teams
- allows teams a safe area to rest and reorganise
- improved ability to control and track resources
- more effective and efficient personnel check-in
- planning for resource use and contingencies is easier, and
- reducing traffic congestion.

B.2 Assembly Area

Assembly Areas are managed by Logistics, and used for receiving, organising, storing, and transporting resources. They may be established at local, regional, and national levels. They allow a coordination centre to deal with large volumes of resources.

Assembly Areas need to be located away from incident sites, preferably at an established facility. Usually there is one EOC Assembly Area servicing multiple incident sites. An ECC usually has one Assembly Area if road transport is not interrupted, otherwise there may be more, so all areas have access to CDEM Group resources. Assembly Areas may be co-located with other responding agency facilities, to allow response personnel to more easily draw on the resources within the Assembly Area, and to reduce accommodation, catering, and other support requirements.

Possible locations for Assembly Areas include:

- council owned or contractor depots
- warehouses or distribution centres
- airports, ports, railway yards, and other transport nodes, and
- sports grounds.

Considerations when establishing Assembly Areas

When establishing an Assembly Area at any response level, consider:

- Logistics sub-functions the Assembly Area will provide, and the required personnel to achieve this. The structure of an Assembly Area will depend on the sub-functions that will be established and on the volume of resources it needs to manage
- the occupational health and safety requirements to reduce risk for response staff in the new facility
- staffing and resource needs
- communications between the Assembly Area, coordination centre and other response elements, and
- size of the selected site, entry and exit, area for storing resources and for unloading vehicles.

The potential requirements for a comprehensive Assembly Area are listed in Table B-1 on page 77.

Table B-1 Requirements for an Assembly Area

Requirement	Description
Management	Personnel to oversee the coordination, control and administration of the Assembly Area. This should be sited close to the main entrance, to allow visitors easy access to key personnel.
Equipment	Communications, computers, furniture, stationery, signage, forklifts, generators, lighting, utility and transport vehicles, tarpaulins, and tents.
Entry and exit	Preferably separate from each other to prevent congestion, with the unloading/loading point between. A separate pedestrian access point may be required. Personnel may be posted at entrances to provide directions to entering response personnel and for security.
Supply and warehousing area	Supply requires an area for storing resources, next to an area for breakdown, packing and loading, and easy for transport to enter and exit. Cover will be needed for some resources, such as food or electronics. Office space will also be required for staff to use the inventory systems to track the resources.
Transport area	To park vehicles, and to organise movement of resources, including personnel, within the affected area. This should be close to the supply and warehousing area, to allow easy loading of vehicles.
Accommodation	For Assembly Area staff, and possibly for other responders, including ablutions (toilets and showers).
Catering area	To provide meals for response personnel and/or the affected population. May be provided by a commercial contractor.
Breakdown, packing, and loading area (hardstanding)	An area of hard surface where resources can be broken down, packed, and reloaded for onwards delivery. For example, a shipment of sandbags might be received in a shipping container, but need to be sent to several different incident sites as pallets or bundles.
Security	Established if there is a security threat to an Assembly Area. Assembly Areas often contain desirable resources, so theft is a possibility, especially if the local population is experiencing significant privation. Perimeter control (fences, patrols) and personnel identification for access may be required, as well as permanently staffed entry and exit points. Alarms may be required for desirable and critical resources.
Maintenance area	Space for equipment to receive routine maintenance (preferably hardstanding) may be required, especially when a response lasts more than 2-3 days. This should be sited close to the transport area, which will be a primary user of maintenance services.
Helipad area	Helipad area for any helicopters allocated to Logistics. The helicopter operators involved need to assist in determining a suitable site, ideally close to the supply and warehousing area.
Civil Defence Centre	An area for receiving evacuees or other people arriving on Logistics transport from the affected area, before they are moved (as soon as possible) to another Civil Defence Centre set up for Welfare needs, or to family or friends. The centre is run by the Welfare function, with the facilities and transport under the control of the Assembly Area. This is only a consideration if an evacuation is part of the response.

As shown in Table B-1 on the previous page and Figure B-2 below, there are a large number of requirements, in terms of personnel, facilities and equipment, needed to establish a full-scale Assembly Area.

Therefore, it is preferable to use existing organisations, such as council depots or logistics companies on contract, to create large Assembly Areas.

This model is scalable. For example, Supply may be in a warehouse, or a single tent, and Transport may have several dozen trucks, or a pair of vans. An Assembly Area should only be as big as the response requires, and resources allow.

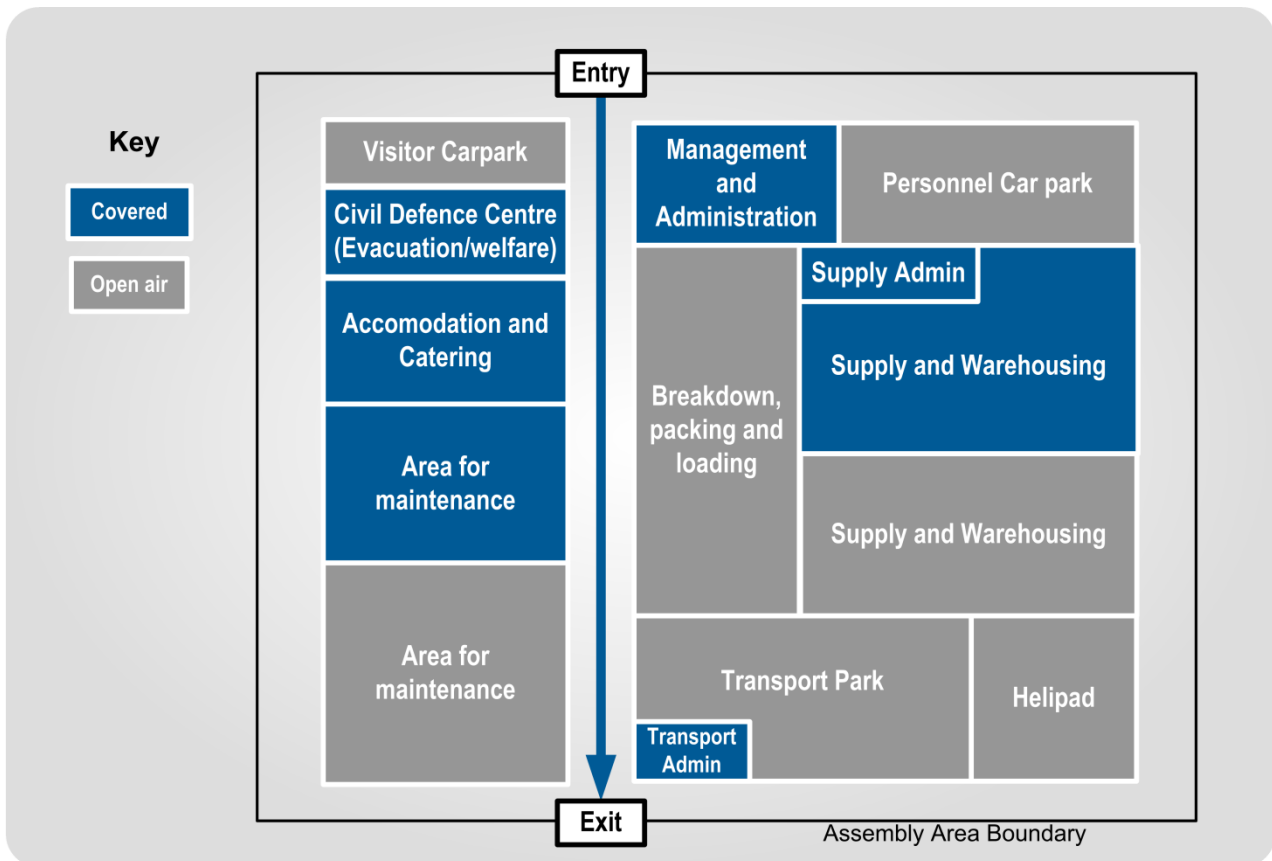

Figure B-2 Example layout of an Assembly Area

APPENDIX C Developing a Logistics CDEM Plan

A *Logistics CDEM Plan* describes what logistics activities are intended to be carried out during response and recovery, and how to prepare for them. It is prepared during the readiness phase. This appendix summarises what needs to be included.

When a *Logistics CDEM Plan* is prepared, it must be approved by the GEMO Manager (if planning is taking place at a Group level) or the EM Officer (if planning is taking place at a local level).

C.1 Content

Describe the overall Logistics function structure, including:

- the coordination centre structure
- Logistics' role within the coordination centre structure, and
- Logistics' structure including any Logistics teams or personnel assigned elsewhere (such as Assembly Areas). The teams should cover all of the sub-functions. Remember that appointments and teams can cover multiple sub-functions.

Sub-functions

Sub-functions are delivered by teams. A team may cover multiple sub-functions, depending on the staff available and the assessed need for each sub-function. State which sub-function each team delivers.

For each of the sub-functions include:

- their roles and specific responsibilities
- their structure in the coordination centre and any other place they may have personnel deployed (such as Assembly Areas or ICPs), and personnel numbers required for each mode of activation, and
- the content described in Table C-1 below.

Table C-1 Sub-function procedures content

Sub-function	Content to include
Management (Logistics)	<ul style="list-style-type: none">• Management appointments (alternate Managers, 2ICs).• Reporting framework.• Logistics contribution to response planning.
Finance section	<ul style="list-style-type: none">• Describe the Finance Team in the coordination centre.• Include the procedures for:<ul style="list-style-type: none">○ approving and paying invoices○ making cash advances and payments○ auditing○ tracking costs○ establishing financial delegations.

Sub-function	Content to include
Supply	<ul style="list-style-type: none"> • Description of supply chain, from requests to the Supply team on to providers and back to the requester. See Figure 7 Supply relationships at a coordination centre on page 23. • The procurement and Resource Request processes.
ICT	<ul style="list-style-type: none"> • Describe communications arrangements (phone, e-mail, radio etc). • Describe IT setup for the coordination centre, as well as from the coordination centre to other parts of the response. • Describe fault procedure and connection to BAU IT office
Administration	<ul style="list-style-type: none"> • Describe how the coordination centre is supplied and maintained, and list the points of contact for these. • Describe the rostering system, how it is developed and where it is stored. • Describe the document management system, and how to access it. • Describe catering arrangements for the coordination centre. • Describe access control, if Administration is responsible for access.
Personnel	<ul style="list-style-type: none"> • Describe volunteer registration system, and also how staff are categorised, trained and accommodated.
Transport	<ul style="list-style-type: none"> • State that if Transport is not established during response, these responsibilities are carried out by Supply. • Describe how resources are moved within the CDEM Group/ local authority, when CDEM Logistics is providing the transport (can refer to national or agency organised transport if necessary.) • List any dedicated vehicles, and likely transport providers.
Facilities	<ul style="list-style-type: none"> • Describe the Facilities team in the coordination centre. • List tasks that the Facilities team are likely to perform (e.g. find response accommodation, find Welfare Centre or Assembly Area locations, maintain coordination centre etc.). Include criteria. • Describe in outline how accommodation for response personnel might be provided in the area. • List points of contact for potential facility hire.
Catering	<ul style="list-style-type: none"> • State that if catering is not established during response, these responsibilities are carried out by Supply. • The structure of Catering staff and teams at coordination centre and/or Assembly Areas. • The procedure for calculating catering figures. • The procedure for ordering and delivering meals to response personnel (with Transport). • Likely providers.

Individual Procedures

Include the processes and documentation prepared under Section 5 [Readiness](#) on page 48 (see also Appendix F [Logistics readiness checklist](#) on page 92 for a full list). This needs to include the items listed in Table C-2 and Table C-3.



Guidance on response procedures is given in Appendix G [Logistics response procedure](#) on page 94.

Table C-2 Procedures to include



Topic	Content to include
Role descriptions	<ul style="list-style-type: none"> • Role descriptions of all positions in Logistics.
Requests process	<ul style="list-style-type: none"> • The procedure for sending Resource Requests. • The procedure for receiving Resource Requests. • (see Appendix K Resource Request procedures on page 105).
Resource processes	<ul style="list-style-type: none"> • The procedure for assessing resource needs. • The procedures related to procuring resources (sources, restrictions, purchasing, and requisitioning). Include MOUs with suppliers. • Include Offers of Assistance and donations. How these are received, how the donor is acknowledged and how they are recorded. • The procedures related to resource management (receiving, storing, issuing, return or disposal, and tracking).
Readiness checklist 	<ul style="list-style-type: none"> • The checklist to be followed during the readiness phase. See Appendix F Logistics readiness checklist on page 92 for an example.
Response checklist 	<ul style="list-style-type: none"> • The checklist to be followed during a response. See Appendix H Logistics response checklist on page 97 for an example.

Table C-3 Appendices to include

Appendices	Content to include
Financial processes	<ul style="list-style-type: none"> • The procedures for managing finances during response and recovery. • The procedures for applying for government assistance at the beginning and end of events. • List any pre-approved financial delegations and authorisations, cost codes.
Personnel and appointments	<ul style="list-style-type: none"> • List all appointments, with potential staff members and their contact numbers against each appointment. This will need to be updated at least annually.
Vendor list	<ul style="list-style-type: none"> • List any vendors or suppliers. Some may have contracts or MOUs in place, some may be other government agencies who have agreed to provide resources. • List any likely commercial providers, where these have not had contracts or MOUs created.
Assembly Area	<ul style="list-style-type: none"> • Describe the structure, the responsibilities for key appointments, and the teams. • List the triggers for activation. • List the likely location(s). • List the resources needed to establish it.

APPENDIX D Government financial assistance

The following sets out the requirements and procedures for local authorities when requesting government financial assistance for response and recovery costs for civil defence emergencies. This appendix needs to be read alongside the *Guide to the National CDEM Plan*.

Local authorities are initially responsible for meeting the cost of all emergency expenditure arising out of the use of resources and services provided under the direction of a Controller (or other response coordinator). Particular care should be taken to keep a clear record of who authorises any expenditure. See D.2 [Claim form](#) on page 86.

D.1 Financial assistance after an emergency

Assistance from REMAs	MCDEM Regional Emergency Management Advisors (REMAs) are available to provide advice on the claims process and guidance on eligibility criteria. Note that MCDEM regional personnel only provide advice. Preparing and submitting claims is the responsibility of the local authorities involved.
General principles	Principles for government financial support are outlined in the <i>National CDEM Plan</i> .
Types of claims	<p>Claims can be made for 'caring for the displaced', 'other response', and 'recovery'. Eligible costs of 'caring for the displaced' are reimbursed at 100 percent, whereas eligible 'other response' and 'recovery' costs are reimbursed at 60 percent above a certain threshold. The claim(s) are assessed against the threshold as outlined in the <i>Guide to the National CDEM Plan</i>.</p> <p>Local authorities can make:</p> <ul style="list-style-type: none">• one claim for all expenditure items, with the items listed in the categories 'caring for the displaced', 'other response', and 'recovery', or• one claim for items related to 'caring for the displaced' submitted first, with all other items in a second claim, with the categories 'other response', and 'recovery'.

Maintaining a record during response and recovery

To support claims for financial assistance, during response and recovery, local authorities should:

- fill in the local authority's relevant resource and finance forms, and
- create a spreadsheet of items.

The suggested column headings for the spreadsheet are:

- item number (starting at 1, allocate consecutive numbers)
- date of invoice
- invoice number
- supplier
- goods and services type
- reasons item needed
- authorised by (name and role)
- cost (excluding GST), and cost (including GST), and
- running total (excluding GST).

Before making a claim

Before they can make a claim for government financial assistance, local authorities must:

- pay all expenses, and
- list and total the expenditure items in a spreadsheet (see above).

Evidence

The claiming authority is required to:

- declare the claims are true and accurate, and
- submit appropriate evidence of expenditure signed by the chief executive of the local authority.

Where relevant to the claim, the chief executive must also provide written confirmation:

- that all river system and essential infrastructure repair assets on which this claim is being sought are directly owned by the local authority
- the local authority can meet its share of the recovery costs, and
- that all assets claimed against were managed consistent with 'reasonable practice' in the sector.

Appropriate evidence of expenditure requires:

- maintaining records of expenditure with cost codes
- outlining the reasons for the expenditure, and
- collating receipts and invoices for all items (with item numbers).

Required content for claim

Information to support claims should be provided using a form (see Appendix D.2 [Claim form](#) on page 86) or covering letter. All claims should contain:

- the local authority name, address, telephone number, contact person
- a description of the event and damage, and
- costs and calculations.

Additional information is required for claims for 'other response costs':

- the net capital value of the local authority's district or region as stated in its annual plan and consequent threshold. Refer to the *Guide to the National CDEM Plan*
- amount of claim (60 percent of costs above the threshold), and
- a breakdown of any 'other response costs' and an explanation of how they meet the eligibility criteria.

Further information is also required for 'recovery' claims:

- list of eligible assets damaged by event
- cost of restoration or repair (GST exclusive) on an asset by asset basis
- other eligible costs – itemised and GST exclusive. Costs are to be actual, unless MCDEM has previously agreed to accept estimates
- evidence that any river management or flood control works/repairs are necessary to avoid major community disruption or continued risk to life, and
- combined total cost.

Submitting a claim

Once the local authority has prepared the material required for a claim, it can submit the claim to Director, Civil Defence Emergency Management through the REMA.

Processing of claims

The local authority will be advised of the outcome of their claim and will be asked for any additional information that may be required to assess the claim. The government may audit the claim.

Advance payments

In emergencies where local authorities are expected to face significant response and recovery costs, advances of these costs can be made, based on local authority estimates. Any advances are offset against subsequent claims. Advance payments require approval from Cabinet.

Refer to the *Guide to the National CDEM Plan* for more information.

Disaster recovery funds

The Government through the Minister of Civil Defence, together with either the Prime Minister or the Minister of Finance has the ability to make a contribution of up to \$100,000 (GST inclusive) to a disaster recovery fund. Larger contributions require Cabinet approval.

Refer to the *Guide to the National CDEM Plan* for more information.

Special policies

Additional financial assistance may be available under some circumstances by way of 'special policies'. Special policies are those policies which are required to establish new programmes to meet the specific needs for emergency recovery in an affected region, or are required to achieve the funding over and above that available from existing departmental funding.

Consideration of proposals for special policy financial assistance will be dependent on:

- the applicant justifying the need for government funding of their proposal through evaluation of options and other funding sources, and having consulted affected communities, and
- the provisions made for risk management by the applicant.

Refer to the *Guide to the National CDEM Plan* for more information.

Other government assistance

The *Guide to the National CDEM Plan* also provides information on assistance provided to local authorities for road and bridge repair, and general clean-up operations (through (Enhanced) Taskforce Green).

The *Guide* also provides information on financial assistance available to households and individuals, and to businesses and farmers, affected by emergencies.

D.2 Claim form

CDEM expenditure claim			
Local authority			
Date of claim (yyyy-mm-dd)		Date(s) of emergency (yyyy-mm-dd)	
Prepared by (Name and role)			
Details of emergency			
Details of claim	Circle one or more: Caring for displaced / other response costs / recovery costs		
Amount claimed	Caring for the displaced		\$
	Other response costs		\$
	Recovery costs		\$
	Total		\$
Attachments			
Claim authorised			
Chief executive name			
Chief executive signature			
Date signed (yyyy-mm-dd)			

APPENDIX E Content for forms

This appendix describes the content for the following forms:

- Resource Issue Register
- Transport Tasking
- Offers of Assistance, and
- Resource Requests.

E.1 Resource Issue Register

Form header

The form header (repeated at the top of each page) needs to include:

- 'Resource Issue Register'
- agency name
- response (for example, Ruapehu Eruption)
- facility (e.g. Wainui EOC, Queen St Assembly Area), and
- page number.

Columns

The columns in Table E-1 should be included.

Table E-1 Contents of a Resource issue register

Item	Description
Date	The date the resource is issued (<i>yyyy-mm-dd</i>).
Resource	Resource being issued; common name is acceptable rather than the definition in the <i>Resource Classification Guide</i> .
Quantity	Quantity being issued (e.g. 40 litres, 40 boxes, 400, etc).
Serial number	If the resource has a unique identifying number, note this down here. N/A if there isn't one.
Issued to	Name and position of the person receiving the resource.
Organisation	Organisation of the person receiving the resource.
Signature	Signature of the person receiving the resource.
Issued by	Name of the person giving the resource.
Returned	The date that the resource was returned. N/A if it is not being returned.
Receiving signature	Signature of the person receiving the resource when it is returned.
Notes	Any extra information that will be useful.

E.2 Transport Tasking

- Form header** The form header (repeated at the top of each page) needs to include:
- ‘Transport Tasking form’
 - agency name
 - response (for example, Ruapehu Eruption)
 - facility (e.g. Wainui EOC, Queen St Assembly Area), and
 - page number.

Columns Table E- 2 lists the information that needs to be in a transport task form.

Table E- 2 Contents of Transport Tasking records

Item	Description
Date	The date the task is created (<i>yyyy-mm-dd</i>).
Task	A description of the allocated task (e.g. deliver 100,000 sandbags to Smith Street stopbank site). Include the EMIS task number if EMIS is in use.
Priority	Task priority, as given by the coordination centre (either Operations or Logistics).
Vehicles	Resources that have been allocated (e.g. 4 x vans).
Departure time and location	Departure location and time.
Destination	Where the task will unload. If it is reloading at the destination to carry a load back, this should be noted as a separate task.
Contact at destination	Name and contact phone number of the person who the delivery is going to. This might be a person at the destination waiting to receive the resources, or the leader of a group to be transported.
Expected time of return	Expected time of return.
Notes	Any extra information that will be useful, such as any intermediate stops, dangerous goods, whether the trip is one-way only etc.

E.3 Offers of Assistance

It is easier to match offers to resource needs when the offers are recorded in an EMIS list or a spreadsheet. The following table lists headings for an Offers of Assistance list or spreadsheet.

When one offer contains multiple resources, enter each resource into its own line.

Columns

Table E-3 lists the information that needs to in an offer of assistance form.

Table E-3 Contents of an Offer of Assistance form

Field	Description
Message reference	Reference the message that contains the original offer (e.g. EMIS message number, time and date of an e-mail etc).
Resource class	Use the Resource Classes in the <i>Resource Classification Guide</i> (in EMIS Global documents in the 'EMIS Reference Material' Library).
Resource sub-class	Use the Resource Sub-class, as described in the <i>Resource Classification Guide</i> .
Resource type	Use the Resource Type, as described in the <i>Resource Classification Guide</i> .
Resource name	Type in the generic, commonly used name. Include the size and capacity.
Quantity	List the quantity offered, including units of measure (litres, pallets, kilograms, boxes etc).
Organisation name	If from a commercial or non-government organisation, note the name.
Contact name	Name and/or appointment of the person who made the offer, or who will arrange the offer.
Contact phone	Landline and/or mobile phone of the person who made the offer, or who will arrange the offer.
Contact email	Email for the person who made the offer, or who will arrange the offer.
Cost	If the offer requires payment, note the cost here.
Location	Current location of the offered resources (which may differ from the location of the person making the offer).
Acknowledged	Has this offer been acknowledged? A 'Yes/No' field is sufficient for this.
Status	Record whether the offer is 'refused', 'not yet accepted', 'accepted', 'awaiting delivery', 'received' or 'returned'.
Notes	Any additional useful information, such as whether the offer is donated or payment is required, the offer's duration, and whether the offer must be accepted within a certain time.

Note that EMIS has an Offer of Assistance form, which is simply a variation of the standard message form. If an agency wishes to record the offers with more accuracy, the form listed here can be used. An alternative is to use the EMIS form, but modify the heading to give resource type and quantity so that the list can be assessed without having to open individual messages.

E.4 Resource Request

This form is in EMIS. ‘*’ indicates compulsory fields that must be filled in. Any fields not filled in need to be answered ‘N/A’ rather than being left blank, to indicate that the field has been considered rather than missed. These fields need to be completed when using manual forms. Table E-4 lists the information that needs to in Resource Request form.

Table E-4 Contents of a Resource Request form

Field	Description
Contact name *	Put both the name and appointment of the requesting person. This is so that if that person is not present, questions can be directed to the current appointment holder.
Contact phone *	Use the phone number for the requester’s coordination centre location, rather than a personal number. This is so that questions can be directed to the team in the coordination centre if the requester is not available.
Status *	When filling in the form, set the status to ‘Assigned’. The status definitions are: <ul style="list-style-type: none"> • Assigned - request has been entered, procurement has not started. • Future - request has been entered, will be approved or actioned at a later date. • In Progress - procurement is underway, but not completed. • Completed - resources have been procured and delivered to the requested location. • Cancelled - request has been entered, but the resource will not be procured (it may no longer be needed, may not be available, or may not have been authorised).
Date and time of the request *	This field is completed automatically in EMIS.
Priority *	The three priority levels are high, medium, and low. The default level is low, unless there is a clear operational need for urgency.
Brief description of problem or task to be accomplished *	Describe the task that the resource is needed for. If the priority is set to high or medium, explain why this task is so important to the response, and what the effect would be if it is not received.
Specific resource requested *	Detail the resources needed. Give the name and details of the resources, as well as the Class, Type, and Subtype from the <i>Resource Classification Guide</i> . The latter will help to avoid misunderstandings around naming and size. <p>Example 1: Portable toilets (static), with urinal and hand sanitizer</p> <ul style="list-style-type: none"> • Classification: Equipment • Sub-Classification: Toilets/Ablutions • Type: IV: Single Portable Toilet <p>Example 2: 40+ seater bus</p> <ul style="list-style-type: none"> • Classification: Vehicle • Sub-Classification: Bus • Type: I: >39 Seat <p>The <i>Resource Classification Guide</i> can be found in EMIS Global documents, in the EMIS Reference Material Library.</p>

Field	Description
Quantity required *	List the number required, including the unit of measurement (e.g. single items, tonnes, boxes, pallets, metres).
Capacity *	Describe the capacity (size, voltage etc) required, e.g. 50kVA for a generator, 20,000 L for water tanks.
Potential substitute *	Describe any alternative options, in case the requested resource is unavailable.
Supporting equipment*	Describe any equipment needed to operate this resource, such as generators, fuel types, and water. If this is specified as part of the Resource Request don't repeat it here.
Personnel required to operate or support *	List the numbers and qualifications of any personnel required to operate and support the resource. If the operators and support personnel are already in location, then put 'N/A'.
Transportation required *	Describe if transport is needed to move the resource to its destination, and any particular requirements (e.g. cold storage, flatbed trailer).
When is resource required *	State the date and time resource is required in location, ready for use.
How long resource is needed *	State the length of time this resource is required. Give an end date if this is known.
Where to deliver or report - address *	Delivery street name and number.
Where to deliver or report - city *	State the local authority of the resources' destination, rather than the 'city'. For Auckland locations use the pre-amalgamation local authority name, as these are in the mapping database; e.g. Waitakere or Manukau, rather than Auckland.
Where to deliver or report - region *	State the region that the delivery location is in.
Where to deliver or report - postcode *	NZ Post postcode.
Where to deliver or report - country *	New Zealand.
Deliver or report to whom: name and position *	Name & position of the person to report to on delivery of resource.
Deliver or report to whom: agency *	Name of agency of person who it to be reported to on delivery of resource.
Deliver or report to whom: contact number *	Contact number of the person to report to on delivery of resource. Include the office or appointment number, rather than a personal phone number, in case the person is absent.

APPENDIX F Logistics readiness checklist

This (optional) checklist is for use by CDEM personnel responsible for preparing for Logistics before an emergency occurs.

References are to sections in this guideline.

Gathering information (see 5.1 [Gathering information](#) on page 49)

Contact database tasks:			
database has been set up			
database is accessible to all potential members of a Logistics team during an event			
database is updated every 3 months, any hard copies reissued, and users informed			
appropriate email groups have been set up			
Database includes:			
higher response level Logistics contacts		lifeline utilities	
nearby CDEM Groups or local authorities		hospital and health services	
local CDEM roles that work with Logistics		commercial providers	
other local CDEM related organisations			
Supporting CDEM information held and understood by Logistics personnel includes:			
local, regional, and national CDEM structures		links to <i>National CDEM Plan and Guide</i>	
link to the <i>CDEM Group Plan</i>		readiness roles of local CDEM volunteers	
readiness roles of local and CDEM Group staff		response roles of local CDEM volunteers	
response roles of local and CDEM Group staff		recovery roles of local CDEM volunteers	
recovery roles of local and CDEM Group staff			

Planning and or/setting up (see 5.2 [Planning and setting up](#) on page 50)

Tasks completed: (Locations and people identified in this section are available [insert location here])			
initial Logistics team (and a back-up team) is identified		Logistics workspace default location is identified	
Logistics pool is identified for any required rosters		Logistics workspace back-up locations are identified	
Logistics personnel details are updated every 3 months		Assembly Area default location is identified	
Logistics personnel have emergency plans for home		Assembly Area back-up locations are identified	
means of communication set up		required resources are sourced	
hard copies & USBs of required documents set up		Logistics response resource boxes are set up	
Staffing shortfall identified, and request for supplementary staffing developed			

Developing processes and documentation

(see 5.3 [Developing processes and supporting documentation](#) on page 56)

Documentation and processes developed:			
Logistics readiness checklist		descriptions of duties for Logistics team members	
Logistics response checklist		required resources list	
Logistics response procedure (including activation)		Logistics role descriptions	
monitoring and evaluation process			

Training and development (see 5.4 [Training and development](#) on page 61)

Training tasks carried out:			
skill gaps are identified		Logistics personnel participating in exercises	
potential programmes by CDEM and external organisations are identified		Logistics training and development programmes for individual personnel developed	
workshops for CDEM Group Logistics organised		mentoring/shadowing exchanges organised	

APPENDIX G Logistics response procedure

This (optional) template is:

- for use by the Logistics Manager and their teams during an emergency
- completed as part of readiness
- designed to be completed as part of the *Logistics CDEM Plan*, which has supporting information on sub-function processes
- intended to be amended to reflect actual processes used by the Logistics team
- intended to have *grey text* replaced with the required information, and brown text deleted.

G.1 Logistics response activation

- Activation trigger** The Logistics Manager:
1. Is informed of the emergency by:
 - *[insert method – phone call from GEMO duty manager/paged by GEMO activation system], or*
 - natural indications, such as feeling an earthquake.

- Logistics briefing** The Logistics Manager:
2. **(if applicable)** Replies to the activation to confirm availability.
 3. Contacts the *Controller or Response Manager* on *[insert phone number and alternative, or where it is found]* to determine the current situation and response.
- The *Controller or Response Manager*:
4. Briefs the Logistics Manager on the emergency.
 5. If the Logistics Manager does not respond within *[insert time]*, the *Duty Officer/activation system* contacts the back-up person on the roster *[insert phone number and alternative, or where it is found]*.

G.2 Setting up Logistics team and workspace

Note: this may occur before the initial message is sent, during slow onset emergencies such as flooding.

- Setting up Logistics team** The Logistics Manager, or a person delegated by them:
6. Determines the Logistics team members required for the initial response.
 7. Contacts the team members.
 8. Gives them the Logistics workspace address which will be one of (in order of preference):
 - *EOC*
 - *alternate address*
 - other suitable (ad hoc) address as directed by the Logistics Manager.
 9. Tells them the access requirements of *[who holds keys/swipe cards and where are they located]*.

-
10. Asks them their expected time of arrival, and records it.
 11. Sets up a short-term roster.
-

On arrival

Whichever Logistics team member arrives first at the Logistics workspace:

12. Accesses the:
 - workspace, using the *[key/swipe card held where]*
 - Logistics response resources (may be a 'Logistics response box') held *(where)* using the *[key/swipe card held where]*.
 13. Informs the Logistics Manager that they have arrived on site and briefly updates them on the current situation there (is the building safe, are other EOC members present?).
 14. Sets up the physical resources (desks, computers, whiteboards), if necessary.
 15. Other staff assist with this as they arrive.
 16. Sets up an attendance log using the *[what]* template *[held where]*.
 17. Sets up:
 - daily logistics tasks checklist using the *[what]* template *[held where]*.
 - task log using the *[what]* template *[held where]*.
-

Communication with other coordination centres

The Logistics Manager (or person on site delegated by them):

18. Assigns the tasks of setting up communication links, and making contact, if appropriate, with:
 - NCMC Logistics **(if appropriate)** *[insert email addresses, phone numbers, or list that contains them all]*
 - any activated EOCs/ECC Logistics *[insert email addresses, phone numbers, or list that contains them all]*
 - CDCs *[insert email addresses, phone numbers, or list that contains them all]*
 - ICPs *[if Logistics for an EOC]*.
-

Communication within the *[coordination centre]*

The Logistics Manager (or person on site delegated by them):

19. Assigns the tasks of setting up communication with the *[coordination centre]* CDEM roles that need to liaise with Logistics, including: **(insert contact details such as role specific cellphone numbers/ specific role emails etc. for each role)**
 - Operations
 - Welfare
 - PIM
 - Planning, and
 - Intelligence.
-

G.3 On-going logistics tasks

Tasks listed in Logistics response checklist

The Logistics Manager:

20. Carries out the tasks described in the *Logistics Response checklist* [held *where*], under the headings:
 - on-going response work
 - daily logistics checklist
 - purchasing
 - procurement
 - finance, and
 - other logistics tasks and processes as required.

G.4 Winding down

Debriefings

The Logistics Manager:

21. Ensures all unused resources are stored for BAU use, returned, or disposed of.
22. Ensures used resources are replaced.
23. Ensures all Logistics personnel are debriefed before they return to their BAU duties.
24. Participates in CDEM debriefings.
25. Ensures that debrief information is analysed and approved changes made to plans and procedures.

Archiving records

The Logistics Manager:

26. Ensures all Logistics records are archived according to the requirements of the Public Records Act 2005 by following the [what] procedure [held *where*].
-

APPENDIX H Logistics response checklist

This checklist is optional, and is intended to:

- be used alongside the Logistics Response procedure
- be used at the ECC, or at the EOC if the ECC is not activated. If it is used for an EOC when the ECC is activated, the tasks will need to be amended appropriately
- be amended to reflect actual processes used by the Logistics team
- have *grey text* replaced with the required information, and brown text deleted

Ensuring tasks are carried out is the responsibility of the Logistics Manager. The tasks may be assigned to Logistics personnel, unless stated otherwise.

Start up

	Done (tick)	Assigned to	Started (date/time)	Finished (date/time)
Logistics Manager is informed of the emergency		CDEM Duty Officer		
Logistics Manager is briefed by the Controller about current situation and the response		Logistics Manager		
Logistics Manager sets up Logistics team:				
Determine how many Logistics personnel are needed initially		Logistics Manager		
Recruit people for Logistics team from pool using agreed process and set up a short term roster		Logistics Manager		
Set up the Logistics workspace:				
Determine initial location of Logistics team workspace		Logistics Manager		
Set up Logistics workspace with resources and personnel as available				
Logistics Manager attends Incident Management Team (IMT) briefing		Logistics Manager		
Set up communication with other coordination centre				

On-going response work

Logistics Manager's on-going tasks	Assigned to
Liaise with Operations, Planning, Welfare and Intelligence Managers	Logistics Manager
Liaise with Logistics staff at other ECCs/EOCs, and at emergency services	Logistics Team
Carry out daily tasks as listed in following section	Logistics Manager and Team

Daily checklist	Date:						
Logistics Manager daily tasks							
Attend CDEM/IMT briefings at coordination centre, present progress and any issues or concerns							
Review Logistics team requirements (personnel, resources, spaces)							
Ensure tasks recorded in task log are being assigned and completed in good time							
Track expenditure, and raise variances with the Controller							
Track progress of major procurements							
Liaise with Logistics Managers in other coordination centres							
Lead handover briefings at shift changes							
Daily checks – Logistics Manager to carry out remedial actions if not occurring							
Information used by Logistics personnel to update resource requirements is current							
All logistics tasks are written in the task log, and signed off when completed							
Critical resources are being identified and managed effectively							
Approval processes for Resource Requests are being followed							
Records of all information (incoming, or released) is being stored so it is easily retrievable for archiving, and is following naming conventions (see Naming conventions on page 63)							
Logistics personnel are having regular breaks during their shifts							
There are sufficient Logistics personnel being included in the pools for the rosters to: <ul style="list-style-type: none"> • cover the required skills • ensure Logistics personnel are getting days off for rest and recuperation 							
Staff handovers at the transition from one shift to another are completed with new information and outstanding tasks passed on							
Logistics personnel are managing stress, and getting enough nourishment and refreshment							

Winding down

	Done (tick)	Assigned to	Started (date/time)	Finished (date/time)
Ensure all unused resources are stored for use during BAU, returned, or disposed of				
Return any facilities used to their BAU state				
Debrief Logistics personnel before they return to their BAU roles, as teams and/or individuals				
Provide Logistics issues and learnings to CDEM debriefing sessions				
Ensure new resources are ordered to replace used stock				
Ensure plans and procedures are updated to reflect debriefing lessons				
Ensure all records are archived, following the requirements of the <i>Public Records Act 2005</i>				

APPENDIX I Logistics Appendix for the Action Plan-template

- A word version is available at www.civil.defence.govt.nz
- Any *grey text* needs to be filled with the relevant data, and brown text needs to be deleted
- This template is intended to be amended to suit the Logistics team needs.

Logistics Appendix for the:	<i>[Action Plan 00x]</i>	Date	<i>[yyy-mm-dd]</i>
Coordination Centre	<i>[CC name here]</i>	Emergency	
Prepared by	<i>[name and role]</i>	Approved by	Controller <i>[name]</i>

Logistics hazard and situation

[Insert a brief description of the situation and hazard impacts, as they apply to the logistics function. Do not just repeat the situation report]

Higher response level logistics plan

[If there is a higher response level activated, include a brief description of how they will support the logistics function in this coordination centre. Do they have an assembly area, are they procuring any resources, are they arranging travel etc.]

Logistics plan of action

Logistics objectives *[list the objectives that the Logistics function is working to. These do not have to be the response objectives, but rather ones developed by Logistics that should support the Action Plan]*

Concept of logistics support *[insert a coordination centre, or distributed to an Assembly Area and to emergency sites? Does everything have to be requested, or will some resources be pushed to response teams? Will some functions or areas be prioritised over others?]*

Tasks *[list specific tasks for logistics teams and for lower response level logistics functions]*

Sub function arrangements

[list specific arrangements for each sub function]

Supply

Finance

Administration

ICT

Catering

Facilities

Personnel

Transport

Coordinating instructions

Key timings:

Locations:

The **Logistics team roster** is available in *[insert name of document and where to find it, or who to contact]*

Logistics control arrangements

Logistics team structure

[Insert structure diagram]

Logistics Manager *[dedicated phone number]*

Logistics team Manager 2IC *[dedicated phone number]*

Finance Manager *[dedicated phone number]*

Supply Manager *[phone number]*

[Insert other roles as appropriate]

The **Logistics team role descriptions** are listed *[insert name of document and where to find it, or who to contact]*

Logistics meetings are scheduled for *[insert where, when, topic (if applicable), and attendees]*

Attachments

Include any maps, tables and supporting information that is too long to contain in the body of this appendix.

APPENDIX J Logistics Appendix for the Action Plan-example

Logistics Appendix for the:	Action Plan 02	Date	2014-06-01
Coordination Centre	Wainui DC	Emergency	Smallville flood
Prepared by	J. Smith	Approved by	Controller S. Watene

Logistics hazard and situation

Hazard

- Flooding in the south of the district has closed roads to the city and isolated numerous farms. Vehicles will need to reroute via Blacktown.
- Floodwaters have breached the stopbank at Rangipo St and Riverside Road.
- Landslide has closed main hardware supplier in Smallville, will need to procure construction stores from Blacktown.
- Low cloud and bad weather likely to interfere with helicopter operations, particularly resupply of isolated farms for the next 3-4 days.
- Smallville Airfield likely to be out of action for 2 days, due to rising flood waters.

Situation

- TDC and SDC also activated in response to this flood. ECC activated at Mode 3.
- Major stopbank repair operation underway on Rangipo St, staging area established at Riverview Park.
- Multiple farms in the south of the district are isolated. Stock-feeding likely to become an issue by 3 June 2014.
- Civil defence centres with accommodation for evacuees are at North School, Queen's Park and Southside Intermediate.
- TDC is main priority for resources from ECC, due to greater degree of damage.

Higher response level logistics plan

CDEM Group

- CDEM Group concept of support is to centralise regional and national procurement through the ECC, rather than each local authority doing it independently. Resources will go direct to EOCs, as no Assembly Area will be established unless situation worsens and resource requests increase.
- ECC Logistics are sourcing staff and equipment from other local authorities to supplement our response.
- ECC coordinating regional procurement, and liaising with NCMC Logistics if necessary.

National

- NCMC activated to Mode 2. Government assistance is not available at present, but a claim may be made after the emergency. REMA available to advise.
- NCMC is arranging travel for supplementary personnel.

Logistics plan of action

Logistics objectives (in support of the Action Plan)

- Provide resources to response elements and public in a timely manner
- Ensure communication systems between response elements are operational and maintained
- Accurately account for expenditure of all funds

Concept of logistics support

The response will be supported by centralising logistics support at the EOC. Resources will either be sent out on tasks or arranged from the EOC as requested. Supply and Finance activities are the key sub-functions for this response. EOC Logistics staff may be attached to the Rangipo St stopbank operation if required, to support ICP logistics and improve receipt and tracking of resources.

Tasks

- Support the stopbank repair operation on Rangipo St
- Deliver food and essential supplies and stock feed to identified farms
- Receive, accommodate and assign supplementary staff
- Track all expenditure and provide an accurate statement of costs

Sub function arrangements

Supply

- Resources to be received at EOC. Where received at incident sites, site Logistics staff to verify correct resources received.
- Critical resources:
 - Sandbags
 - Helicopters
 - Construction lighting

Finance

- Delegations: Controller (40k), Response Manager (10k), Logistics Manager (10k)
- Special budget code for this response: 26335

Administration

- No change to SOPs

ICT

- Cellphone, e-mail, and landline systems operating. Radio and satphones are not in use.
- Contact list attached.
- No change to SOPs.

Catering

- Meals provided by Bob's Catering, delivered to site by transport. Managed through Supply.

Facilities

- No additional facilities identified. If needed, Supply will manage.

Personnel

- No need identified. If needed, Administration will manage.

Transport

- Transport demands managed by Transport planner at EOC.
- 2 light helicopters (Stag Helicopters) and 4 light vans available.
- Delivery of construction material provided by the supplier, managed through Supply.

Coordinating instructions

Key timings:

Stopbank staging area established: 11:00, 2 June

All farms being resupplied by: 12:00, 4 June

Locations:

EOC: Council office, Smallville

Assembly Area: None

Staging Area: Rangipo St stopbank repair, at Riverview Park

The **Logistics Team roster** is available on the roster whiteboard by the entrance, and in the shared drive under 'Smallville Floods/Admin/Roster. There are three shifts:

- Shift 1: 0600-1400
- Shift 2: 1330-2130
- Shift 3 (skeleton shift): 2130-0600

Logistics control arrangements

Logistics team structure

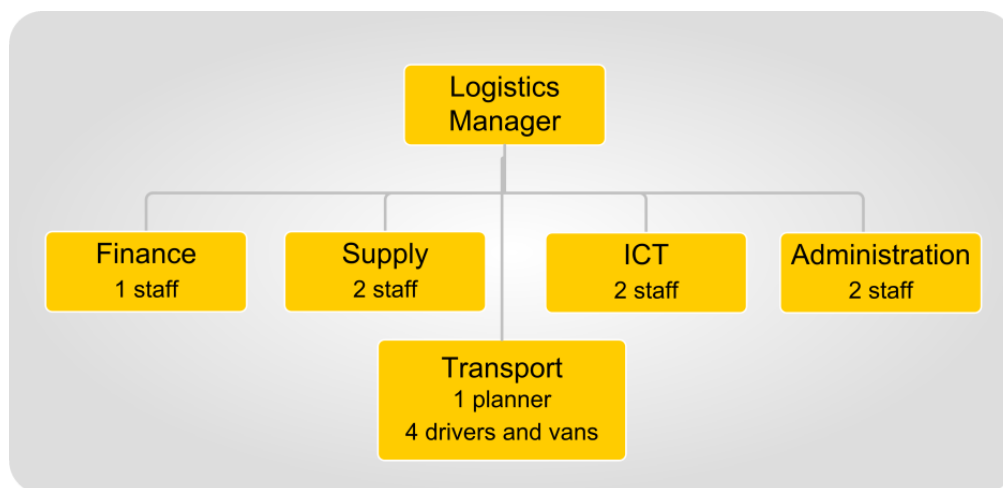

Logistics Manager Jonathan Wanoa, 04-598-669

Logistics team Manager 2IC/Supply Team Leader Samantha Vercoe, 04-598-670

Finance Manager Bruce Singh, 04-598-632

The **Logistics Team role descriptions** are listed in the shared drive under 'CDEM Response/Procedures/Logistics'.

Logistics meetings are scheduled for 1000 and 1700 hours, at the Logistics desk. Team leaders to attend.

Attachments

1. Phone and e-mail contact list

APPENDIX K Resource Request procedures

This appendix includes example processes for sending and receiving Resource Requests.

K.1 Procedure for submitting a Resource Request

Before completing and submitting a Resource Request, assess the need for it, to ensure that a request is required. See 4.1 [Resource assessment](#) on page 33 for more information.

Submitting Resource Request to another coordination centre

Once the Resource Request has been completed, the Logistics Manager or Supply team leader:

1. Reviews it to ensure it has all the required information.

If using EMIS:

2. Click the 'Save and Close' button. This automatically sends it to the receiving ECC/NCMC 'Incoming Messages' list on the Communications page.
3. If approved by the Operations Manager in the receiving coordination centre, Operations assign a resource to the task, and advise Logistics to supply it.
4. If the resource is not available, a task to procure it is assigned to Supply for action.
5. If this request is a high priority, the requesting coordination centre Controller should call the receiving Controller, as it threatens a key operational task. If a medium priority, the Logistics Manager should call the receiving Logistics Manager, to emphasise the requirement, gain a timeframe for delivery and to answer any questions.

If EMIS is not in use, or the receiving agency does not use it, the Resource Request needs to be sent as an email or fax, using the above process.

Regardless of the process used, once a Resource Request has been submitted, it should be followed up with phone calls and visits, to help track progress.

Submitting Resource Request within the coordination centre

Not all Resource Requests are sent to an external agency for procurement. They may also be sent from one function to another. In these cases, the staff in the requesting function should work with their Logistics colleagues to ensure that the request is filled in with the appropriate information.

Where the request has a high or medium priority, the function manager should discuss this with the Logistics Manager.

K.2 Procedure for processing received Resource Requests

Receiving the Resource Request

Operations:

1. Receives the Resource Request (from CDEM coordination centres one level down, or from other agencies' same-level coordination centres), usually with their other messages via Communications.
2. Verifies any unclear information with the requester.

Logistics:

3. Informs the Operations Manager of any requests that include critical resources
 4. Passes any Resource Requests received directly by Logistics back to Operations for initial logging and approval.
-

Approving the Resource Request

The Operations Manager:

5. Decides whether to approve the Resource Requests, after consulting with the Logistics Manager or Controller, particularly if critical resources are being requested.

If a request is not approved, the Operations Manager:

6. Returns the Resource Request by email, explaining why it was turned down.

If it is a medium or high priority request, the Operations Manager:

7. Calls the Operations Manager at the originating centre to acknowledge receipt, or if it is for critical resources, the Controllers may need to discuss the matter.

If approved, Operations EITHER:

8. If EMIS is being used, creates a task for Logistics to procure the resource.
 9. If EMIS is not being used, passes the signed hard copy to Logistics for them to procure.
-

Recording the Resource Request

If EMIS is being used, the Resource Request is automatically saved as a task assigned to Logistics.

If EMIS is not being used, Logistics:

10. Assigns a number to the Resource Request.
11. Enters the details onto a list or spreadsheet.

Logistics:

12. Verifies any unclear information with the requester.

If correspondence and other information needs to be kept with a Resource Requests, Logistics:

13. Creates a library in EMIS, or folder on the coordination centre shared drive.

Verifying and prioritising the Resource Request

Supply:

14. Checks that all information is clear.

If anything needs clarification, Logistics:

15. Contact their counterparts at the requesting centre and clarifies the Resource Request.

If all of the information in the Resource Request is clear, Supply:

16. Allocates a priority to the Resource Request, considering the priority given by the requester, the other Resource Requests received, the type of resource, and Supply's workload.

If the request can't be met in the requested time, Logistics must contact the requester to confirm this verbally and work out an alternative solution.

Advising requester

Logistics:

17. Advises the requester that their Request has been approved and that procurement is underway.
18. Gives the requester contact information (particularly phone numbers) for the Supply team and for any personnel assigned to this task, and if possible, an estimated (and realistic) time for completion.

Procuring the resource

Supply:

19. Procures the resources.
20. Ensures all relevant information is recorded (such as quotes, specifications, contracts, and approvals).
21. Advises the requester well in advance of the arrival date, time and location.

If the Requested Resource is critical, medium, or high priority, or has a long time frame for completion, Supply:

22. Updates the requester regularly and frequently.

Once the resource has arrived, Supply:

23. Organises transport to the destination unless transport has already been arranged to the end-user.

Create the resource record

Once the resource has arrived, Supply:

24. Creates a Resource Record in EMIS, (or on spreadsheet or T Cards if EMIS is unavailable) including any relevant information such as who controls the resource, and its status (e.g. en route, available).

Make payment

When the invoice arrives (if applicable), Finance:

25. Organises payment of the invoice.

APPENDIX L Task log

If more space is required for an entry, complete a task sheet.

Task no.	Task sheet y/n	Time created	Task requirements	Assigned to	Actions taken	Time completed	Signed off by
1							
2							
3							
4							
5							
6							
7							
8							
9							
10							
11							
12							
13							
14							
15							
16							
17							
18							
19							

Task no.	Task sheet y/n	Time created	Task requirements	Assigned to	Actions taken	Time completed	Signed off by
20							
21							
22							
23							
24							
25							
32							
33							
34							
35							
36							
37							
38							
39							
40							
41							
42							
43							
48							
49							
50							

APPENDIX M Task sheet

This is used to record tasks that require more information than there is space for in the task log.

Task requested by					
Task number (from task log)		Time/date logged in		Needed by (time)	
Time full task completed		Signed by (name)		Signature	

Requirements		Assigned to	
Actions taken		Time/date completed	By whom

APPENDIX N Procurement phases during an emergency

Reference



This appendix is based on the government document *Quick Guide: Emergency Procurement*. This is available at <http://www.business.govt.nz/procurement>, by searching 'emergency procurement'.

N.1 Phase 1 – Immediate response (reactive procurement)

When applies

The immediate phase of reactive procurement:

- only applies if the emergency:
 - results in the destruction of response resources or infrastructure, OR
 - has a greater magnitude than resource planning catered for.
- occurs:
 - in the first hours or days of a response (usually 12-48 hours)
 - when ECCs/EOCs are still mobilising, and
 - communications are degraded or unworkable.

Expectations

Logistics personnel are not required to follow normal procurement procedures; however, they are required to demonstrate sound reasoning and good judgement.

Government guidance

Government guidance for reactive procurement is:

- obtain the necessary goods or services direct from suppliers
- keep a record of what has been purchased
- no written contract is required
- ask suppliers to invoice after the situation has stabilised (in phase 2)
- act within existing delegated authority, where possible
- if there is no existing delegated authority and no time to obtain an approval, then exercise good judgement and be prepared to justify the nature and extent of the procurement in the circumstances, and
- if a purchase involves a major expense, it is recommended, at the very least, that a verbal approval from an officer with sufficient delegated financial authority is obtained before making the commitment. This must be recorded in the Operations Log or similar document, along with the reasons for the purchase.

N.2 Phase 2 – Disaster relief (emergency procurement)

When applies

The disaster relief phase of emergency procurement:

- begins when:
 - ECCs/EOCs are staffed to an operational level, and communications are working at a basic level.
 - the need to react immediately changes to a need to respond urgently
- continues:
 - for weeks (possibly)
 - until the response has ended, OR
 - until response is transitioning into recovery, at a time determined by the Logistics Manager.

Government guidance

Government guidance for emergency procurement is:

- identify, specify, and prioritise the immediate procurement required to bring relief
- consider the operating environment and conditions ‘on the ground’
- if possible, find out what other government agencies and NGOs are doing, and where practicable, collaborate
- purchase directly from the most convenient suppliers. Consider price, but overriding consideration must be the immediate provision of relief
- always obtain financial approval prior to the purchase. Where appropriate, ECCs/EOCs could make a blanket approval to cover this stage of the emergency response during their pre-event planning
- consider options for sourcing, including contracts already in place. Consider using another agency’s suppliers (e.g. Police, Health) where they have been appointed through a competitive process if that supports immediate delivery
- when there are no existing contracts, identify quotes that can be achieved quickly and suppliers who can deliver immediately. Verbal or email quotes are sufficient. When a quote is verbal, make a record of the conversation in the Operations Log and/or EMIS
- check what assurance suppliers can give to delivering immediately, to the right location, the right quantity and quality, at the right price
- advise suppliers that the purchase is being made as an emergency procurement to provide immediate relief and that a more competitive process will be used for any medium to long term solution
- when possible, consider alternative contract solutions, such as short term lease of equipment rather than purchasing. This may allow time to source a longer term solution through a more competitive process
- confirm your agreement with the supplier in writing – an email is sufficient. You need include only the basics: what is being delivered, to what specification, when, where, by whom, the price and any other charges, for example freight and insurance.

N.3 Phase 3 – Post-disaster recovery (accelerated procurement)

When applies

The accelerated procurement phase applies:

- when the emergency situation has stabilised, and the recovery is transitioning towards reconstruction and remediation
- to resources that still require an accelerated procurement process, particularly for lifelines utilities and housing, and
- when more flexibility and speed than a BAU process is required, but with a greater level of competition, governance, and accountability than the emergency process.

In many cases, the purchase of resources should return to BAU procedures and practices.

Government guidance

Government guidance for accelerated procurement is:

- clarify that the situation meets the criteria for treatment as an 'emergency' and that a flexible approach to procurement can be fully justified
- identify, specify, and prioritise the accelerated procurement activities that will bring relief
- consider the operating environment and conditions 'on the ground'
- find out what other government agencies and NGOs are doing and, where possible, collaborate
- consider your duty of care to suppliers and take appropriate measures to ensure their safety, and
- seek invoices or estimates, ensure delivery notes come with resources and payments are documented.

APPENDIX O Transport background information

Transport is divided into heavy and light, depending on carrying capacity and the types of loads.

Light transport carries passengers and/or light loads up to one tonne

Heavy transport:

- carries loads of equipment and freight over one tonne
- sometimes may be reconfigured to carry passengers, and
- often requires functional support infrastructure.

Modes of transport

Transport modes are the types of vehicle that are used to move passengers and freight. The main transport modes and their features are listed in the table below.

Table O-1 Modes of transport

Mode of transport	Load capacity	Features	Operational requirements
Road	Depends on vehicle size	Main mode for most responses	At least partially functioning roads and bridges
Off-road	Mostly light, some specialist 4WD trucks	Doesn't need roads	Access across waterways and through property boundaries
Fixed wing	Depends on plane size	Fast	Require working airports or airfields, visibility (no fog or snow)
Rotary wing (helicopter)	Light (some may be heavy)	Fast	Cleared space for helipad, visibility (no fog or snow), manageable winds
Boat	Light	Good in floods	Require navigable waterways, best with wharves or boat-ramps
Barge	Heavy		Require navigable waterways, can use beach landing areas
Ship	Heavy		Need functional ports, unless specialised military craft
Rail	Heavy		Need intact rail tracks

Transport nodes

A transport node is a place where loads and passengers:

- change from one transport type to another; for example, an airport is where people change from road to planes and vice versa
- are organised into new configurations to match the different type of transport. For example, a shipping container of sandbags is broken down into bales that are then loaded into a group of 4WD utes.

Types of transport nodes

Types of transport nodes include:

- ports
- airports
- railhead (places where trains are unloaded onto other modes of transport.)
- beach landing site
- helipads (may be temporary or permanent)
- distribution centres (permanent hub, usually road based, may include rail), and
- Assembly Areas.

Figure O-1 shows the link between transport modes and nodes.

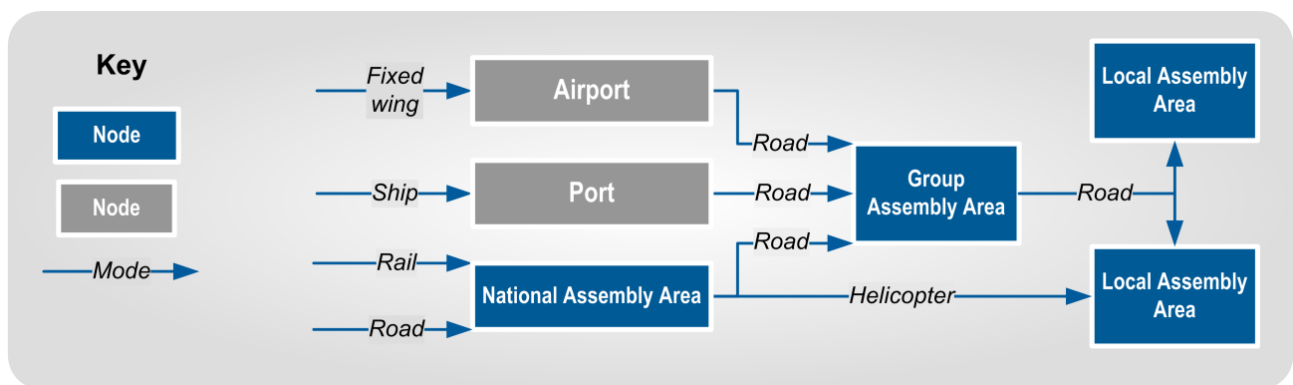

Figure O-1 Transport nodes and modes

Transport tasking

Transport tasking can be centralised, decentralised, or a combination of these. The features of centralised and decentralised tasking are summarised in Table O-2.

Table O-2 Features of centralised and decentralised transport tasking

Feature	Centralised	Decentralised
Vehicles base	One central location	Multiple locations
Example locations of bases	The coordination centre, Assembly Area or transport yard	EOCs, response teams, and incident sites
Transport control	Coordination centre's Logistics' Transport team	Transport team at the local base
Best used when	Fewer vehicles, so a need to prioritise transport	Damaged transport routes or communications, and sufficient vehicles to allocate
Advantages	More efficient allocation of total vehicle pool More options available for each task	Quicker response times for local tasks
Disadvantages	May take more time to respond	Difficult to combine capacity for key tasks

APPENDIX P Glossary

Term	Abbreviation (if any)	Definition
4Rs		Reduction, readiness, response and recovery (see individual entries).
Accelerated procurement		Used where a response situation is stabilising, and the purchasing system is transitioning from emergency procedures back to BAU. Accelerated procurement is more streamlined than BAU processes, but is more robust than other emergency procurement arrangements.
Ad hoc		Ad hoc means arrangements that are organised after the response activates, rather than being planned in detail during readiness. It may involve community groups that have reorganised away from their primary focus (e.g. sports clubs assisting stopbank operations or volunteer 'armies' forming to clear roads). Ad hoc does not imply ineffective or disorganised activities.
Administration		A Logistics sub-function that arranges clerical support, cleaning, maintenance, pool vehicles and record-keeping, (especially key response documents), particularly in a coordination centre.
Agencies		Government agencies (including public service departments, non-public service departments, Crown entities, and Offices of Parliament), non-governmental organisations, lifeline utilities, and emergency services.
Business as usual	BAU	Refers to structures, practices, and procedures that apply when there is no emergency response; i.e. during normal conditions.
Catering		A Logistics sub-function that provides meals and drinks to response personnel.
CDEM Group Plan		Each CDEM Group is required under the CDEM Act 2002 to have a CDEM Group Plan, which is regularly reviewed. The CDEM Group Plan sets the strategic direction for the CDEM Group. It describes and prioritises the hazards and risks particular to the CDEM Group's area, and provides objectives and a framework for activities across the 4Rs.
CDEM organisation		Any part of a CDEM Group or local authority that has responsibilities in CDEM.
Coordinated Incident Management System	CIMS	A proactive incident management framework that systematically manages incidents regardless of size, hazard and complexity. Pronounced 'sims'.
Consumable		Resources that are not expected to be returned once assigned to an end user, as they are consumed; e.g. food, aggregate, fuel.

Term	Abbreviation (if any)	Definition
Controller		The person in charge of an emergency, or of a response element. The level of their control is given by the name – National Controller (usually based at the NCMC), Group Controller (usually based at an ECC), Local Controller (usually based at an EOC) and Incident Controller (at an ICP)
Coordination centre	CC	A facility to support a Controller in coordinating a response, or their part of it. Coordination centres may be activated to support incident, local, regional, or national level responses. They include Incident Control Points (ICPs), Emergency Operations Centres (EOCs), Emergency Coordination Centres (ECCs), and National Coordination Centres (NCCs).
Director of CDEM		The head of MCDEM, who reports to the Minister of Civil Defence. The Director has the role of National Controller during an emergency led by CDEM, unless they choose to delegate this role.
Emergency Management Officer	EM Officer	The person who manages the Emergency Management Office (EMO) at a local level.
Emergency procurement		Procurement and purchasing that happens after the immediate response, when the situation is stabilising but is still far more dynamic than in BAU. It can continue for weeks, and uses a much more streamlined approach than normal procurement.
Facilities		A Logistics sub-function that secures buildings and land for use by response personnel, and maintaining these throughout the response.
Finance		A Logistics sub-function that tracks response costs, pays accounts and invoices, provides authorised cash advances, and audits financial accounts.
Group Emergency Management Manager	GEMO Manager	The person who manages the Group Emergency Management Office (GEMO).
Heavy transport		Transport that carries loads of equipment and freight over one tonne, though it can sometimes be reconfigured to carry passengers.
Incident		An occurrence that needs a response from one or more agencies. It may or may not be an emergency.
Information Communications Technology	ICT	A Logistics sub-function that establishes and maintains the communications links and information technology networks in the coordination centre. Communications receives messages, logs them, and then distributes them to relevant functions, and sends radio or courier messages on behalf of other functions.
Issue		When a resource is formally passed from one party to another. The recipient may need to sign a receipt or register to acknowledge and record that the resource has been received.

Term	Abbreviation (if any)	Definition
Lead agency		The agency that manages a particular emergency. Some agencies are required by law to lead particular types of emergencies; other types of emergencies will have the lead agency determined by expertise.
Light transport		Transport that carries passengers and/or light loads up to one tonne.
Local authority		A territorial authority, regional council, or unitary authority.
Logistics management		A Logistics sub-function that coordinates and manages the other Logistics sub-functions, and provides logistics advice to the Controller.
Ministry of Civil Defence & Emergency Management	MCDEM	The central government agency responsible for providing leadership, strategic guidance, national coordination, and the facilitation and promotion of various key activities across the 4Rs. It is the lead agency at a national level responsible for coordinating the management of CDEM emergencies. MCDEM may act as a support agency by coordinating the CDEM response to any given emergency managed by another lead agency. MCDEM is responsible for maintaining the National Crisis Management Centre (NCMC), and for the National Warning System.
Mode		Modes are the types of transport vehicle that are used to move passengers and freight, such as road, off-road, helicopters, ships and barges.
National Crisis Management Centre	NCMC	A secure, all-of-government facility used by agencies to monitor, support, or manage a response at the national level. MCDEM is responsible for maintaining the NCMC in a state of readiness, and will act as the lead agency for CDEM-led responses.
Node		A transport node is a place where loads and passengers change from one transport type to another or are organised into new configurations to match the different type of transport. They include ports, airports, railheads and distribution centres.
Plain English		Communication in English that is clear, brief, and avoids jargon.
Personnel		A Logistics sub-function that manages human resources, including registering and training response personnel (including spontaneous volunteers), and payment of staff (where required).
Readiness		Developing operational systems and capabilities before an emergency happens, including self-help and response programmes for the general public, and specific programmes for emergency services, lifeline utilities, and other agencies.

Term	Abbreviation (if any)	Definition
Reactive procurement		Procurement that takes place in the immediate aftermath of an emergency (usually the first 12-48 hours). It occurs then coordination centres are still mobilising, when communications are degraded, when there has been substantial destruction of response infrastructure and there is a greater need for resources than planned.
Recovery		The coordinated efforts and processes used to bring about the immediate, medium-term, and long-term holistic regeneration of a community following an emergency.
Recovery Manager		The person responsible for recovery. When emergencies will have significant recovery activities, the Controller hands over to the Recovery Manager once most response tasks have been completed, and the Recovery Manager is ready to take over.
Regional council		A region-based council, primarily responsible for natural resource management, including in the coastal marine area. It regulates land use for specific purposes (for example, soil conservation, water quality, and the management of natural hazards). It also regulates for and undertakes pest control and harbour navigation and safety, and provides (in some cases) public transport services.
Regional Emergency Management Advisor	REMA	MCDEM personnel, based at MCDEM's regional offices in Auckland, Wellington and Christchurch. They are responsible for providing advice and support to the CDEM Groups in their geographic area.
Response		Actions taken immediately before, during, or directly after an emergency to save lives and property, and to help communities recover.
Reduction		Identifying and analysing long-term risks to human life and property from natural or non-natural hazards, taking steps to eliminate these risks if practicable, and, if not, reducing the magnitude of their impact and the likelihood of their occurring.
Supply		A Logistics sub-function that procures resources, tracks offers of assistance, and provides supply information to the Planning function. Supply at an Assembly Area is responsible for receipt, storage, inventory tracking, and loading of supplies and equipment.
Support agency		Any agency that assists the lead agency by providing services, resources, information, or otherwise contributing to the response.
territorial authority		A city or district council or unitary authority that provides public services and regulates land use, buildings, public nuisances, and environmental health.
Transport		A Logistics sub-function that provides transport, and for equipment maintenance. Transport works with Supply to transport resources to where they are needed.
unitary authority		A territorial authority with regional council functions and powers.

www.civildefence.govt.nz



**Ministry of Civil Defence
& Emergency Management**

Te Rākau Whakamarumarū